

**LIONHEART**  
- FOUNDRY -



**LFSUPER60-212**  
**USER MANUAL**



# CONTENTS

INTRODUCTION .....	2
FEATURES .....	2
CONTROLS .....	3
FRONT PANEL .....	3
BACK PANEL .....	4
HOW TO CONNECT THE LFSUPER60-212.....	5
ONBOARD LOUDSPEAKER WITH FX LOOP .....	5
USING THE DI OUT .....	5
AUX IN AND HEADPHONES OUT.....	6
FOOTSWITCH CONNECTIONS .....	6
EXAMPLE SETTINGS.....	7
CLEAN .....	7
PUSHED CLEAN .....	7
LEAD .....	7
RHYTHM .....	7
FULL ON .....	7
SPECIFICATIONS .....	8
DIMENSIONS (in mm).....	9
SAFETY AND WARNINGS .....	10

## INTRODUCTION

Thank you for purchasing your new Laney LIONHEART-FOUNDRY LFSUPER60-212 amplifier.

The LIONHEART-FOUNDRY Series takes the power, dynamism and response of our acclaimed LIONHEART tube amp range and forges them into creative, affordable, high-quality solid-state amplifiers that are practical, feature-laden, portable and a lot of fun!

Your LIONHEART-FOUNDRY LFSUPER60-212 amplifier was conceived, designed, and meticulously crafted by people who know and understand what musicians demand from their purchases.

Every LIONHEART-FOUNDRY amp is designed and built with an attention to detail which is second to none. The LIONHEART-FOUNDRY series gives you everything you need for a great guitar tone and nothing you don't.

The LFSUPER60-212 is a dual channel, vertically aligned 2x12, all analogue 60-Watt guitar combo, packed full of features. It delivers the same pristine cleans, warm overdrive and wide tonal palette of the tube driven LIONHEARTS, plus it boasts built-in vintage styled tremolo and chorus FX too.

And, just like all our FOUNDRY amps, we've made it feel like you're playing a tube amp too. All in a package that is easy to carry and designed to be with you from the practice room to the stage!

Great tone is everything and the LIONHEART-FOUNDRY Series is everything you need and nothing you don't!

For more information about the complete range of Laney amplifiers please visit our website [www.laney.co.uk](http://www.laney.co.uk)

## FEATURES

- High and Low power modes (60W or Low Power <1W bedroom mode)
- Built in foot-switchable Pre-Boost with level
- Two Independent Channels with foot-switchable control designed from the ground up to replicate the Tone AND feel of the Lionheart tube series
- Clean Channel with Bright Switch
- Drive Channel with Gain, Volume and switchable Bright, Natural and Dark voicing
- 3 Band passive tone stack and Tone control
- Digital Reverb with foot-switchable control
- Tremolo and Chorus, with rate and depth controls. (foot-switchable)
- LA-IR High Quality Digital IR emulated balanced XLR Out with selectable 1x12 or 4x12 IR and ground lift switch.
- 2x HH H1260 Loudspeakers
- 6.3mm FX Loop (FX Send doubles as an unemulated line out)
- 3.5mm Stereo Aux In and 3.5mm Stereo Headphone Output (With Cabinet Emulation)

# CONTROLS

## FRONT PANEL

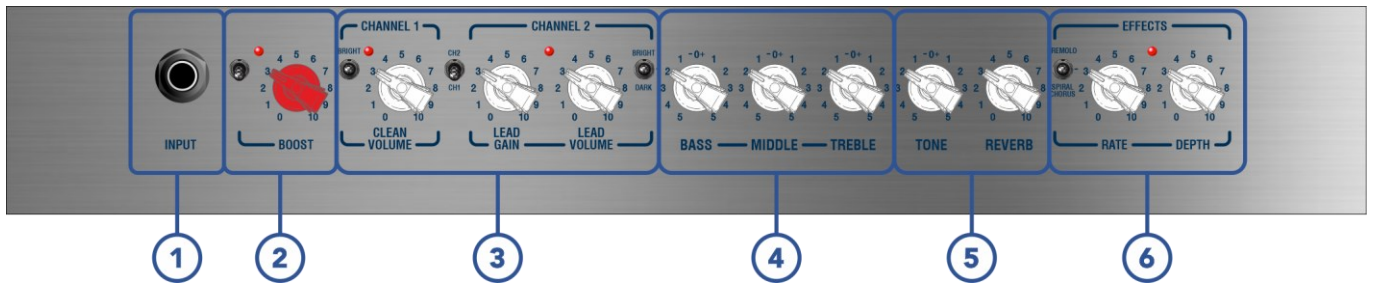

### 1. INPUT SOCKET

6.3mm jack socket for the main audio signal input.

### 2. BOOST CONTROL

Pre-channel boost control with on/off switch.

### 3. CHANNEL 1 + 2 CONTROLS

Individual controls for channels 1+2 with a tone switch for each as well as the channel select switch.

### 4. EQ TONE STACK

3 tone EQ stack to tweak the bass, middle and treble. Passive controls that always sound musical at any setting.

### 5. TONE + REVERB

Tone control to control the top end response of your signal. Reverb control for the built in reverb effect.

### 6. EFFECTS CONTROLS

Choose between tremolo and our Spiral chorus effects. Use the rate and depth to vary the sound of the selected effect.

## BACK PANEL

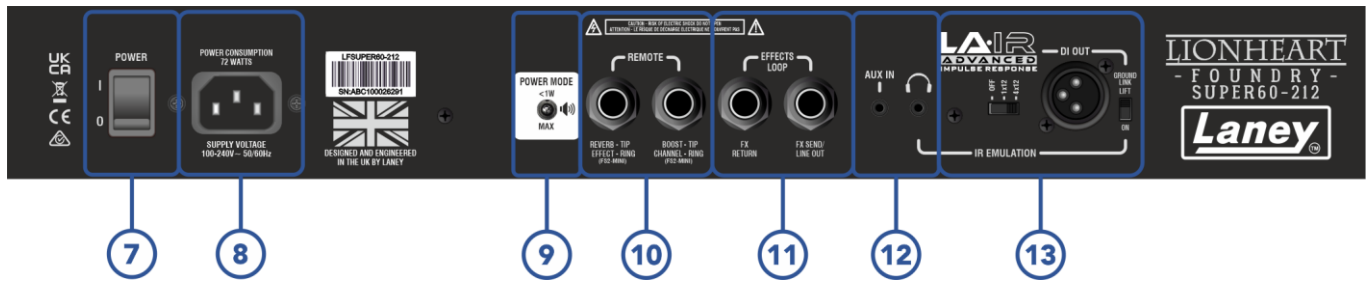

### 7. POWER SWITCH

Main power switch for the unit.

### 8. POWER SOCKET

Universal IEC input socket to connect the provided mains inlet.

### 9. AMP POWER CONTROL

Switch the power output of the amplifier between full power and <1W for quiet playing.

### 10. REMOTE SWITCH SOCKETS

Footswitch sockets to control reverb, effect, boost and channel select.

### 11. FX LOOP

FX return and send to connect to your effects pedals. The FX send can also be used as a standard line level output.

### 12. AUX IN + HEADPHONES OUT

3.5mm aux input socket to add a backing track to your mix. 3.5mm headphones socket for silent playing - will mute the amplifier with a jack connected.

### 13. DI OUT

XLR line level DI out socket with built in emulation for 1x12 and 4x12 cabs. Ground lift switch to potentially resolve ground hum issues.

# HOW TO CONNECT THE LFSUPER60-212

## ONBOARD LOUDSPEAKER WITH FX LOOP

Simply connect your guitar to the input socket via a 6.3mm jack and you're ready to play. To incorporate your effects pedalboard, plug the input and output to the FX send/return sockets respectively.

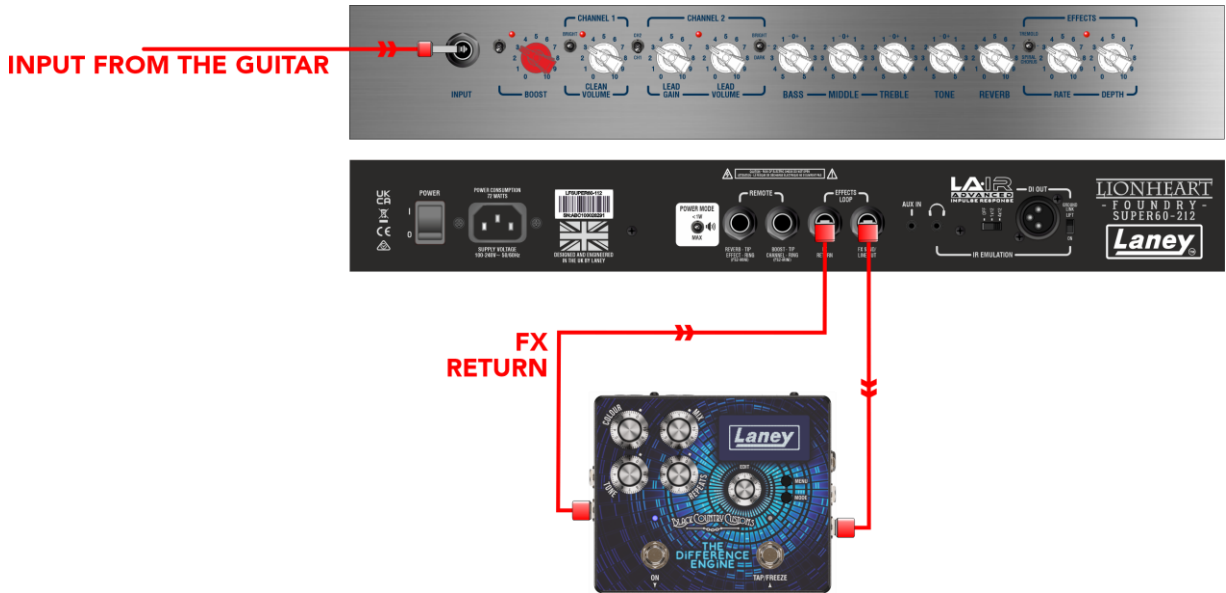

## USING THE DI OUT

The high quality speaker emulated DI out, with IRs preloaded, can be connected to any balanced/unbalanced line level input device such as a PA or audio interface to a DAW. Toggle the cabinet emulation off should you want to use your own.

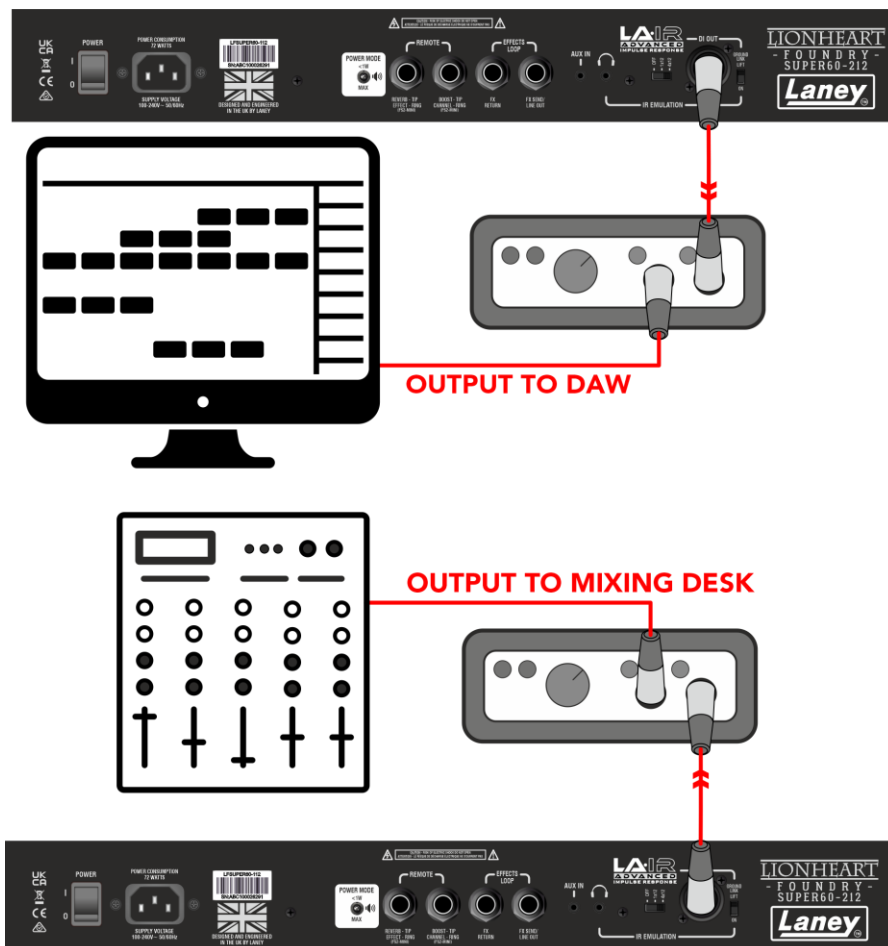

## AUX IN AND HEADPHONES OUT

Connect your backing track via the 3.5mm aux in from any media player device such as a mobile phone. This will play out of the onboard loudspeaker along with your guitar track. Alternatively, for silent practise, plug in a pair of headphones to the 3.5mm phones out socket to have your guitar and backing track play through them with the onboard loudspeaker muted.

Additionally, the phones out also includes cabinet emulation, following the IR emulation switch.

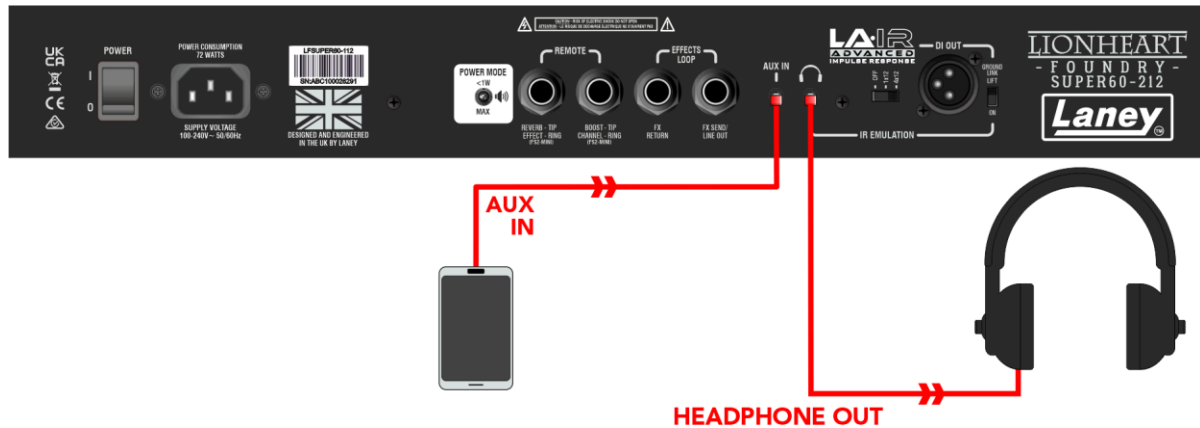

## FOOTSWITCH CONNECTIONS

The two remote sockets on the LFSUPER60-212 can be connected to two FS-2 Minis to allow for remote control of the reverb, effect select, boost and channel select.

The left socket should connect to an FS-2, where the jack's tip signal will toggle the reverb and the jack's ring signal will switch the active effect between tremolo and Spiral chorus.

The right socket should connect to an FS-2, where the jack's tip signal will toggle the boost on/off and the jack's ring signal will switch between channel 1 and 2.

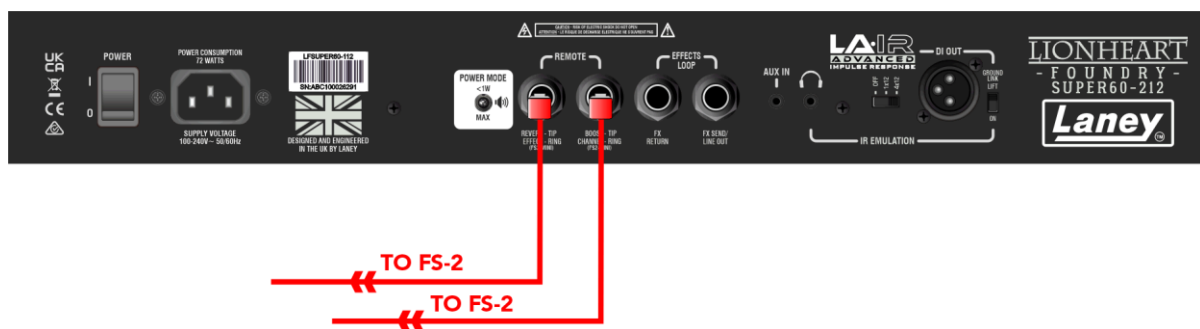



# EXAMPLE SETTINGS

While the EQ on the LFSUPER60-212 is designed to always sound musical, here are a few starters to help you find some familiar tones:

## CLEAN

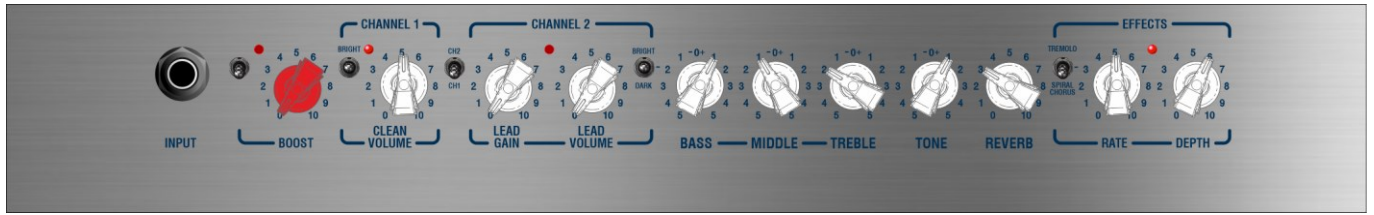

## PUSHED CLEAN

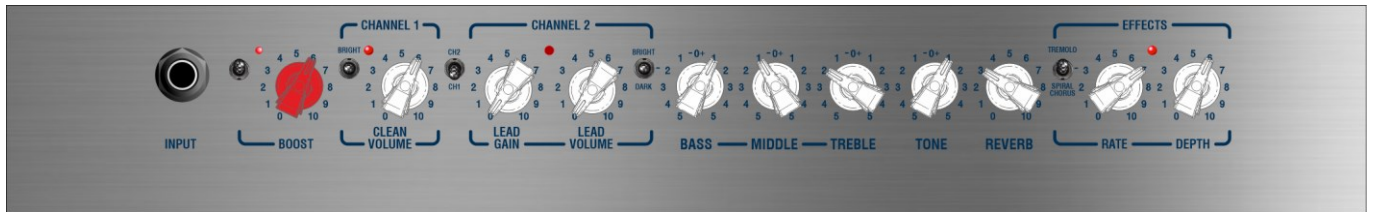

## LEAD

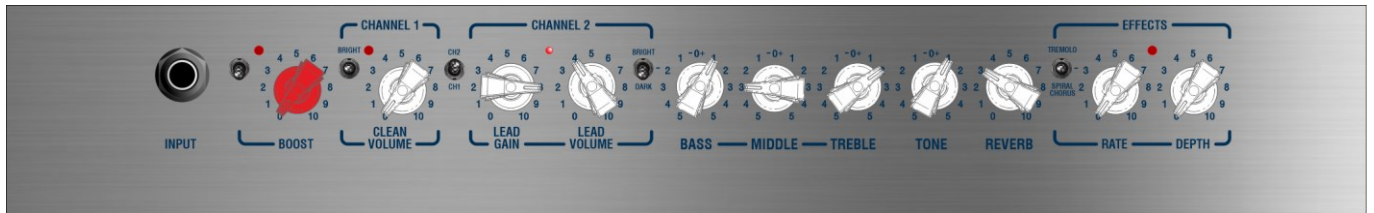

## RHYTHM

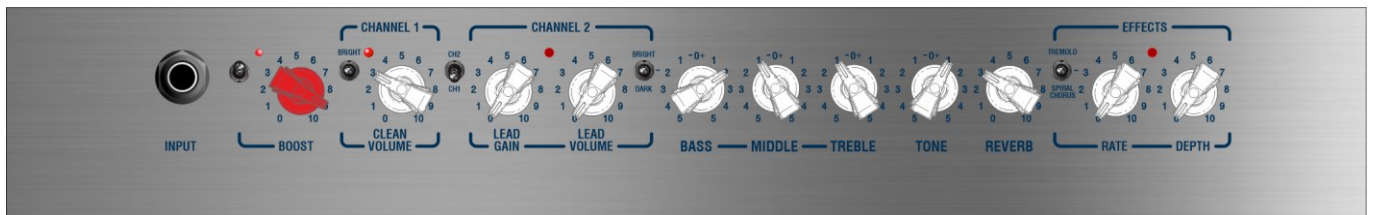

## FULL ON

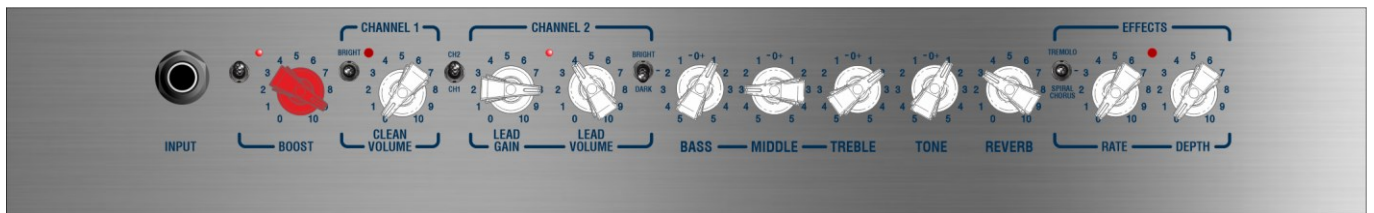



## SPECIFICATIONS

Model No	LFSUPER60-212
Name	Lionheart Foundry Super 60-212
Type	Guitar Amplifier Combo
Input Impedance	1M $\Omega$
Amplifier Power	60W RMS or Low Power <1W bedroom mode)
Channels	Clean and Drive (Footswitchable)
EQ	Bass, Middle Treble (Passive tone stack) Overall Tone Control, plus Bright switch (Clean Channel) and Tone character Switch (Drive Channel)
Effects	Digital Springline Reverb (Footswitchable). Tremolo and Chorus, with rate and depth controls (Footswitchable), External FX Loop
Controls	Pre-Boost, Clean Volume, Clean Bright Switch, Channel Switch, Drive Gain, Drive Volume, Drive Tone Character (Normal, Bright, Dark), Bass, Middle, Treble, Reverb, Tremolo or Chorus Switch, Rate, Depth.
Indicators	LEDs for Boost, Channel 1, Channel 2, and Modulation Effects.
Inputs	6.3mm (1/4") Mono Instrument Input Jack, 6.3mm FX Return jack, 3.5mm stereo aux in jack
Outputs	6.3mm FX Send (Doubles as Line Out), 3.5mm stereo headphone jack, Balanced Male XLR DI out with LA.IR Speaker Emulated Digital Impulse Response with high quality 1x12 and 4x12 options.
Loudspeaker	2x HH H1260 16 Ohm Loudspeaker
Power Supply	Internal SMPSU 100-240V~ Universal Voltage 50/60Hz. IEC C14 Inlet
Typical Power Consumption	72W
Unit dimensions (HWD)	683 x 485 x 260mm, (26.9" x 19.1" x 10.2")
Unit weight	15.8Kg, (34.8 lbs)
Carton dimensions (HWD)	740 x 565 x 335mm, (29.1" x 22.2" x 13.2"), 0.14 M3
Packed Weight	18.6Kg, (41 lbs)
EAN Code (Single)	5060109458893

# DIMENSIONS (in mm)

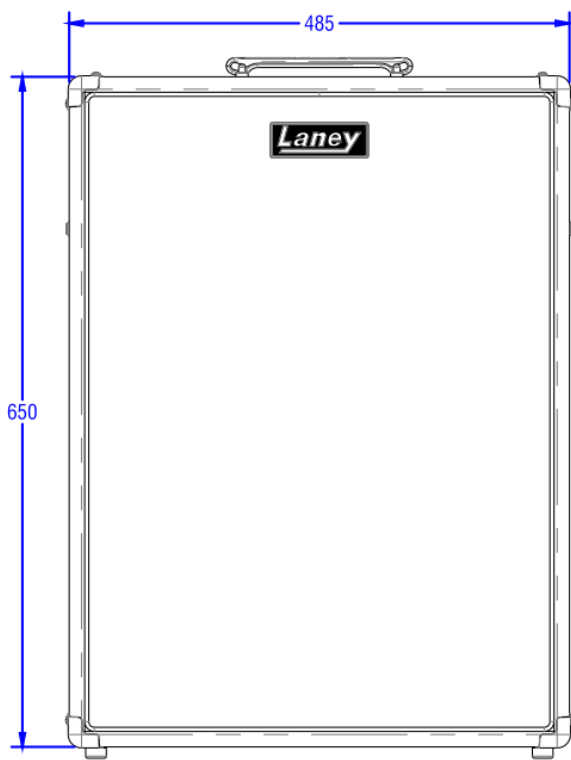
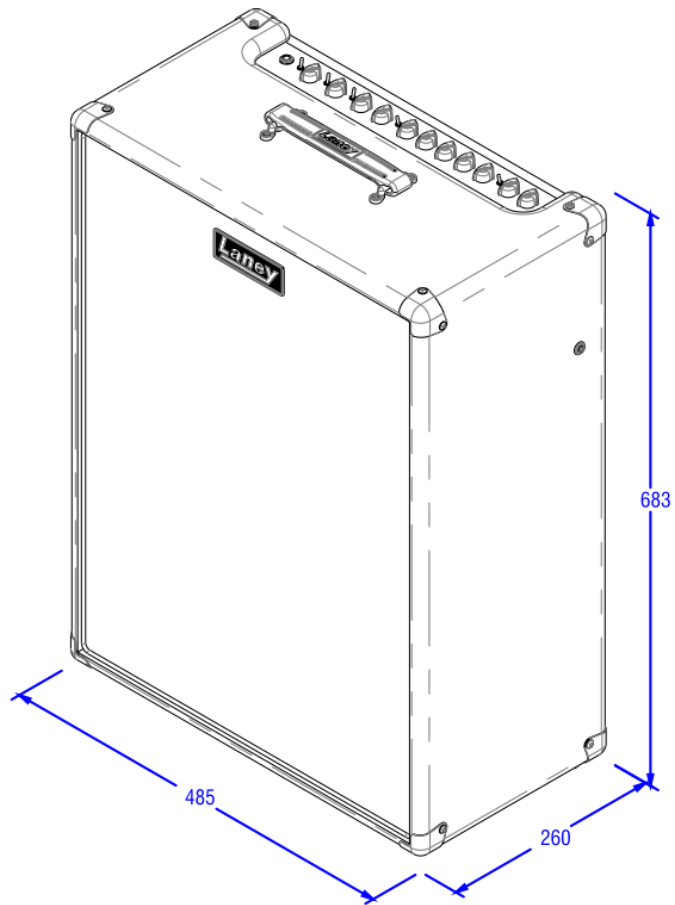

FRONT

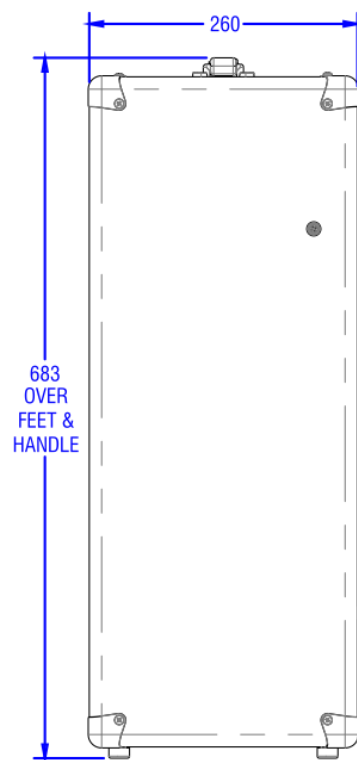







RIGHT

# SAFETY AND WARNINGS

In order to take full advantage of your new product and enjoy long and trouble-free performance, please read this owner's manual carefully, and keep it in a safe place for future reference.

- 1) **Unpacking:** On unpacking your product please check carefully for any signs of damage that may have occurred whilst in transit from the Laney factory to your dealer. In the unlikely event that there has been damage, please re-pack your unit in its original carton and consult your dealer. We strongly advise you to keep your original transit carton, since in the unlikely event that your unit should develop a fault, you will be able to return it to you dealer for rectification securely packed.
- 2) **Amplifier Connection:** In order to avoid damage, Generally it is advisable to establish and follow a pattern for turning on and off your system. With all system parts connected, turn on source equipment, mixers, effects processors etc, BEFORE turning on your amplifier. Many products have large transient surges at turn on and off which can cause damage to your speakers. By turning on your amplifier LAST and making sure its level control is set to a minimum, any transients from other equipment should not reach your loud speakers. Wait till all system parts have stabilised, usually a couple of seconds. Similarly when turning off your system always turn down the level controls on your amplifier and then turn off its power before turning off other equipment.
- 3) **Cables:** Never use shielded or microphone cable for any speaker connections as this will not be substantial enough to handle the amplifier load and could cause damage to your complete system. Use good quality shielded cables everywhere else.
- 4) **Servicing:** The user should not attempt to service these products. Refer all servicing to qualified service personnel.
- 5) Heed all warnings.
- 6) Follow all instructions.
- 7) Do not use this apparatus near water.
- 8) Clean only with a dry cloth.
- 9) Do not block any of the ventilation openings. Install in accordance with manufacturer's instructions.
- 10) Do not install near any heat sources such as radiators, heat registers, stoves or other apparatus (including amplifiers) that produce heat.
- 11) An apparatus with Class I construction shall be connected to a mains socket outlet with a protective connection. Do not defeat the safety purpose of the polarized or grounding-type plug. A polarized plug has two blades with one wider than the other. A grounding type plug has two blades and a third grounding prong. The wide blade or third prong is provided for your safety. If the provided plug does not fit into your outlet, consult an electrician for replacement of the obsolete outlet.
- 12) Protect the power cord from being walked on or pinched, particularly at plugs, convenience receptacles, and the point they exit from the apparatus.
- 13) Only use attachments/accessories provided by the manufacturer.
- 14) Use only with a cart, stand, tripod, bracket, or table specified by the manufacturer, or sold with the apparatus. When a cart is used, use caution when moving the cart/apparatus combination to avoid injury from tip-over.
- 15) The mains plug or appliance coupler is used as the disconnect device and shall remain readily operable. The user should allow easy access to any mains plug, mains coupler and mains switch used in conjunction with this unit thus making it readily operable. Unplug this apparatus during lightning storms or when unused for long periods of time.
- 16) Refer all servicing to qualified service personnel. Servicing is required when the apparatus has been damaged in any way, such as when power-supply cord or plug is damaged, liquid has been spilled or objects have fallen into the apparatus, the apparatus has been exposed to rain or moisture, does not operate normally, or has been dropped.
- 17) Never break off the ground pin. Connect only to a power supply of the type marked on the unit adjacent to the power supply cord.
- 18) If this product is to be mounted in an equipment rack, rear support should be provided.
- 19) Note for UK only: If the colours of the wires in the mains lead of this unit do not correspond with the terminals in your plug, proceed as follows:
  - o The wire that is coloured green and yellow must be connected to the terminal that is marked by the letter E, the earth symbol, coloured green or coloured green and yellow.
  - o The wire that is coloured blue must be connected to the terminal that is marked with the letter N or the colour black.
  - o The wire that is coloured brown must be connected to the terminal that is marked with the letter L or the colour red.
- 20) This electrical apparatus should not be exposed to dripping or splashing and care should be taken not to place objects containing liquids, such as vases, upon the apparatus.
- 21) Exposure to extremely high noise levels may cause a permanent hearing loss. Individuals vary considerably in susceptibility to noise-induced hearing loss, but nearly everyone will lose some hearing if exposed to sufficiently intense noise for a sufficient time. The U.S. Government's Occupational Safety and Health Administration (OSHA) has specified the following permissible noise level exposures: According to OSHA, any exposure in excess of the above permissible limits could result in some hearing loss. Earplugs or protectors to the ear canals or over the ears must be worn when operating this amplification system in order to prevent a permanent hearing loss, if exposure is in excess of the limits as set forth above. To ensure against potentially dangerous exposure to high sound pressure levels, it is recommended that all persons exposed to equipment capable of producing high sound pressure levels such as this amplification system be protected by hearing protectors while this unit is in operation.
 

Duration Per Day in Hours	Sound Level dBA, slow response
8	90
6	92
4	95
3	97
2	100
1 1/2	102
1	105
1/2	110
1/4 ou inférieur	115
- 22) If your appliance features a tilting mechanism or a kickback style cabinet, please use this design feature with caution. Due to the ease with which the amplifier can be moved between straight and tilted back positions, only use the amplifier on a level, stable surface. DO NOT operate the amplifier on a desk, table, shelf or otherwise unsuitable non-stable platform.
- 23) Symbols & nomenclature used on the product and in the product manuals, intended to alert the operator to areas where extra caution may be necessary, are as follows:

 <p><b>CAUTION:</b></p>	<p>Intended to alert the user to the presence of uninsulated 'Dangerous Voltage' within the products enclosure that may be sufficient to constitute a risk of electrical shock to persons.</p> <p>Ce symbole est utilise pur indiquer a l'utilisateur de ce produit de tension non-isolee dangereuse pouvant etre d'intensite suffisante pour constituer un risque de choc electrique.</p> <p>Este simbolo tiene el proposito de alertar al usuario de la presencia de '(voltaje) peligroso' que no tiene aislamiento dentro de la caja del producto que puede tener una magnitud suficiente como para constituir riesgo de corrientazo.</p> <p>Dieses Symbol soll den Anwender vor unsolierten gefahrlichen Spannungen innerhalb des Gehauses warnen, die von Ausreichender Starke sind, um einen elektrischen Schlag verursachen zu konnen.</p>
 <p><b>WARNING:</b></p>	<p>Intended to alert the user of the presence of important operating and maintenance (Servicing) instructions in the literature accompanying the product.</p> <p>Dieses Symbol soll den Anwender vor unsolierten gefahrlichen Spannungen innerhalb des Gehauses warnen, die von Ausreichender Starke sind, um einen elektrischen Schlag verursachen zu konnen.</p> <p>Este simbolo tiene el proposito de la alertar al usario de la presencis de instrucccones importantes sobre la operacion y mantenimiento en la literatura que viene conel producto.</p> <p>Dieses Symbol soll den Benutzer auf wichtige Instruktionen in der Bedienungsanleitung aufmerksam machen, die Handhabung und Wartung des Produkts betreffen.</p>
<p>CAUTION:</p> <p>ATTENTION:</p> <p>PRECAUCION:</p> <p>VORSICHT:</p>	<p>Risk of electrical shock - DO NOT OPEN. To reduce the risk of electrical shock, do not remove the cover. No user serviceable parts inside. Refer servicing to qualified personnel.</p> <p>Risques de choc electrique - NE PAS OUVIRIR. Afin de reduire le risque de choc electrique, ne pas enlever le couvercle. Il ne se trouve a l'interieur aucune piece pouvant etre reparee par l'utilisateur. Confier l'entretien a un personnel qualifie.</p> <p>Riesgo de corrientazo - no abra. Para disminuir el risego de corrientazo, no abra la cubierta. No hay piezas adentro que el pueda reparar. Deje todo mantenimiento a los tecnicos calificados.</p> <p>Risiko - Elektrischer Schlag! Nicht offen! Um das Risiko eines elektrischen Schlages zu vermeiden, nicht die Abdeckung entfernen. Es befinden sich keine Teile darin, die von Anwender repariert werden Konnten. Reparaturen nur von qualifiziertem Fachpersonal durchfuhren lassen.</p>
<p>WARNING:</p> <p>ADVERTISSEMENT:</p> <p>ADVERTENCIA:</p> <p>ACHTUNG:</p>	<p>To prevent electrical shock or fire hazard, do not expose this appliance to rain or moisture. Before using this appliance please read the operating instructions for further warnings.</p> <p>Afin de prevenir les risques de decharge electrique ou de feu, n'exposez pas cet appareil a la pluie ou a l'humidite. Avant d'utiliser cet appareil, lisez les advertissements supplentaires situes dans le guide.</p> <p>Para evitar corrientazos o peligro de incendio, no deja expuesto a la lluvia o humedad este aparato Antes de usar este aparato, lea mas advertcias en la guia de operacion.</p> <p>Um einen elektrischen Schalg oder Feuergefahr zu vermeiden, sollte dieses Gerat nicht dem Regen oder Feuchtigkeit ausgesetzt werden. Vor Inbetriebnahme unbedingt die Bedienungsanleitung lesen.</p>
	<p>This device complies with Part 15 of the FCC rules Operation is subject to the following two conditions:</p> <ol style="list-style-type: none"> <li>1) This device may not cause harmful interference</li> <li>2) This device must accept any interference received, that may cause undesired operation.</li> </ol> <p>Warning: Changes or modification to the equipment not approved by Laney can void the user's authority to use the equipment.</p> <p>Note: This equipment has been tested and found to comply with the limits for Class B digital device, pursuant to Part 15 of the FCC Rules. These limits are designed to provide reasonable protection against harmful interference in a residential installation. This equipment generates, uses and can radiate radio frequency energy and if not installed and used in accordance with the instructions, may cause harmful interference to radio communications. However, there is no guarantee that interference will not occur in a particular installation. If this equipment does cause harmful interference to radio or television reception, which can be determined by turning the equipment off and on, the user is encouraged to try and correct the interference by one or more of the following measures. Reorient or relocate the receiving antenna. Increase the separation between the equipment and receiver. Connect the equipment into an outlet on a circuit different from that to which the receiver is connected. Consult the dealer or an experienced radio/TV technician for help.</p>
	<p>This product conforms to the requirements of the following European Regulations, Directives &amp; Rules: CE Mark (93/68/EEC), Low Voltage (2014/35/EU), EMC (2014/30/EU), RoHS (2011/65/EU), ErP (2009/125/EU)</p> <p>SIMPLIFIED EU DECLARATION OF CONFORMITY</p> <p>Hereby, Laney Electronics Ltd. declares that the radio equipment is in compliance with Directives 2014/53/EU, 2011/65/EU, 2009/125/EU. Full text of the EU declaration of conformity is available at the following internet address:</p> <p><a href="http://support.laney.co.uk/approvals">http://support.laney.co.uk/approvals</a></p>
	<p>The object of the declaration described above is in conformity with the relevant statutory requirement Electrical Equipment (Safety) Regulations 2016, Electromagnetic Compatibility Regulations 2016, The Restriction of the use of Certain Hazardous Substances in Electrical and Electronic Equipment Regulations 2012, The Ecodesign for Energy-Related Products and Energy Information, (Amendment) (EU Exit) Regulations 2012</p>
	<p>In order to reduce environmental damage, at the end of its useful life, this product must not be disposed of along with normal household waste to landfill sites. It must be taken to an approved recycling centre according to the recommendations of the WEEE (Waste Electrical and Electronic Equipment) directive applicable in your country.</p>



STEELPARK ROAD, COOMBSWOOD BUSINESS PARK WEST, HALESOWEN, B62 8HD. UK  
FOR THE LATEST INFORMATION PLEASE VISIT [WWW.LANEY.CO.UK](http://WWW.LANEY.CO.UK)

**IN THE INTEREST OF CONTINUED DEVELOPMENT, LANEY RESERVES THE RIGHT TO AMEND PRODUCT SPECIFICATION WITHOUT PRIOR NOTIFICATION.**

V0.1

