

IRONHEART
- F O U N D R Y -



**IRF-DUALTOP
USER MANUAL**



CONTENTS

INTRODUCTION	2
FEATURES	2
CONTROLS	3
FRONT PANEL	3
BACK PANEL	5
HOW TO CONNECT THE DUALTOP	6
INTO A PASSIVE CAB	6
WITH AN FX LOOP	6
HEADPHONES AND AUX IN FOR SILENT PRACTICE	7
USING THE DI OUT	7
EXAMPLE SETTINGS	8
RHYTHM	8
LEAD	8
CRUNCH	8
CLEAN FUNK	8
SPECIFICATIONS	9
DIMENSIONS (in mm)	10
SAFETY AND WARNINGS	11

INTRODUCTION

In the 1700s the first Newcomen Steam Engines were designed and constructed right here in the heart of England, in the midlands; a 100 years later the skies were black with smog from burning furnaces, fuelling the legendary industrial revolution. This was the beginning of the Black Country. As the fire and brimstone that once scorched the sky began to fade, another type of metal was born:

Heavy Metal; the beating twisted heart of the Black Country.

The IRONHEART FOUNDRY series is forged from fire and iron right at the heart of the Black Country, the legendary furnaces rekindled to create a beast. We, tone blacksmiths of the midlands, have created a monster.

We call it the IRF-DUALTOP, a 60-Watt twin channel amplifier in a compact head format. It's soul, from the IRONHEART that resides in the home of industrial revolution, is designed in the UK by Laney's dedicated design team.

Set to CLEAN, you get crystal clear cleans with sparkle and bite, while setting to LEAD is all about the gain. It can deliver Earth shattering power, from controlled gut punching tones at lower gains to untamed feral roars when really turned up.

The 3 Band EQ section is the tonal offspring of the legendary IRONHEART valve heads, capturing all their nuances and flexibility. This traditional passive tone stack with complex interactivity never sounds bad. As well as the onboard reverb - based on the BCC-SECRETPATH Spring line algorithm, the DUALTOP also features a fully transformer isolated FX loop for a pure, noise free, high-quality signal.

The XLR DI OUT is loaded with two high quality Laney customs IR's and allows you to connect directly to your DAW or FOH giving you totally flexibility for noise free recording and streamlined cab-less stages. You never need to mic a cabinet again.

An auxiliary input and emulated headphone output makes the DUALTOP ideal for practising at home or on the move.

And then, if you dare, the last control. If you weren't already maddened by the insanity of the DUALTOP, the switchable BOOST is there to tip you over the limit. Push your drive tones further and feel the very soul of the IRONHEART scream out.

And yes, it may be small but it's LOUD, you can choose just how loud this monster is by the switchable WATTS control on the rear panel, Max, or <1W ideal for the bedroom.

FEATURES

- 60 Watts RMS
- 2 Independent Channels
- DI output with IR loaded cabinet emulation and ground link switch
- Spring line reverb
- CH1 - selectable ASYM/CLEAN/SYM modes
- CH2 - Bright/Normal/Dark voicing
- 3 band passive EQ tone stack
- Switchable Pre-boost with level control
- Loudspeaker out (8-16ohm)
- High/low power modes (low power <1W)
- Effects loop (Transformer isolated)
- Aux in
- Headphone output
- 100-240V universal voltage power supply included (24V/2.5A)

CONTROLS

FRONT PANEL

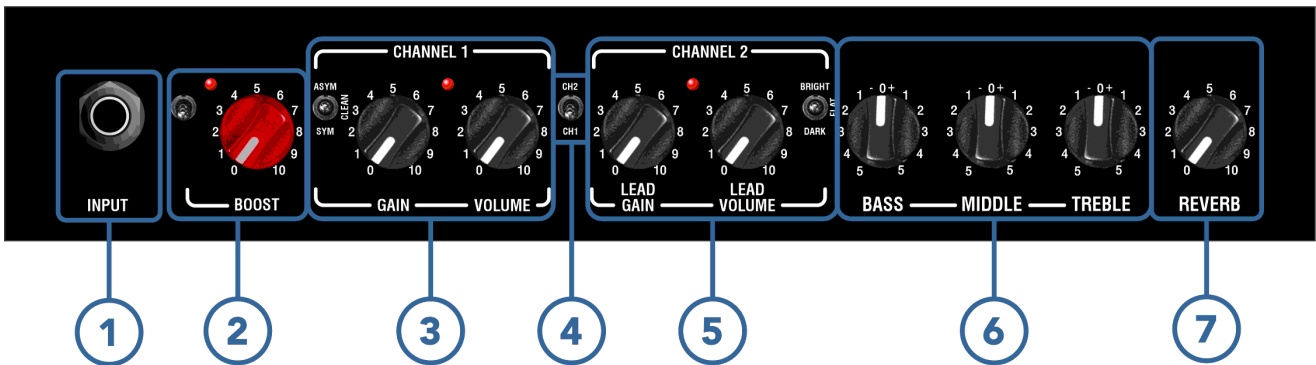

1. INPUT SOCKET

Plug in the input jack from your guitar here, suits any standard 6.3mm mono jack.

2. BOOST CONTROL

The boost control is an additional gain setting that acts as a boost pedal in front of your DUALTOP, driving your signal for more distortion. The LED above the control indicates when it is active and will work on both channels simultaneously. Ensure the switch is set to on when using a footswitch to control it. It's especially pleasing when used to push the clean channel into slight breakup.

3. CHANNEL 1 SETTINGS

Gain and volume settings to control your desired level for channel 1. The Gain Character Switch (GCS) can either be clean, asymmetrical or symmetrical, allowing for refined control over the distortion characteristics of the channel.

- CLEAN - Least amount of compression with this setting, more open tone with softer clipping.
- ASYM - Provides asymmetrical wave clipping adding more distortion whilst retaining some clarity and dynamics. Plenty of second harmonics
- SYM - Symmetrical wave clipping giving a more aggressive distortion for a high gain, compressed sound.

4. CHANNEL SWITCH

Switch between the two channels. Ensure channel 2 is selected when using the footswitch to control channel.

5. CHANNEL 2 SETTINGS

Gain and volume settings to control your desired level for channel 2. Channel 2 has more gain and a voicing switch which can be set to either neutral, bright or dark.

- NEUTRAL - No change to your signal
- BRIGHT - Extends the high frequencies and slightly dulls the low-end.
- DARK - Boosts the low-end frequencies adding some warmth to your tone, whilst reducing the power of the high frequencies.

6. EQ SETTINGS

A 3-band passive EQ stack to further modify your sound. The three controls are linked so however you tweak them, the DUALTOP will always provide you with a musical tone.

- BASS - Adjusts the strength of the low-end response, gives a deeper sound when turned clockwise.
- MIDDLE - Adjusts the strength of the mid-range response, giving a fuller sound when turned up.

- TREBLE - Adjusts the strength of the top-end response, boosting the brighter higher notes.

7. REVERB CONTROL

Our built-in studio quality spring line reverb effect based on our award-winning Secret Path pedal. Reverb is evocative of space - a note contains pitch, but reverb contains place and fills out the sound. Turn the knob clockwise to increase the strength of the effect.

BACK PANEL

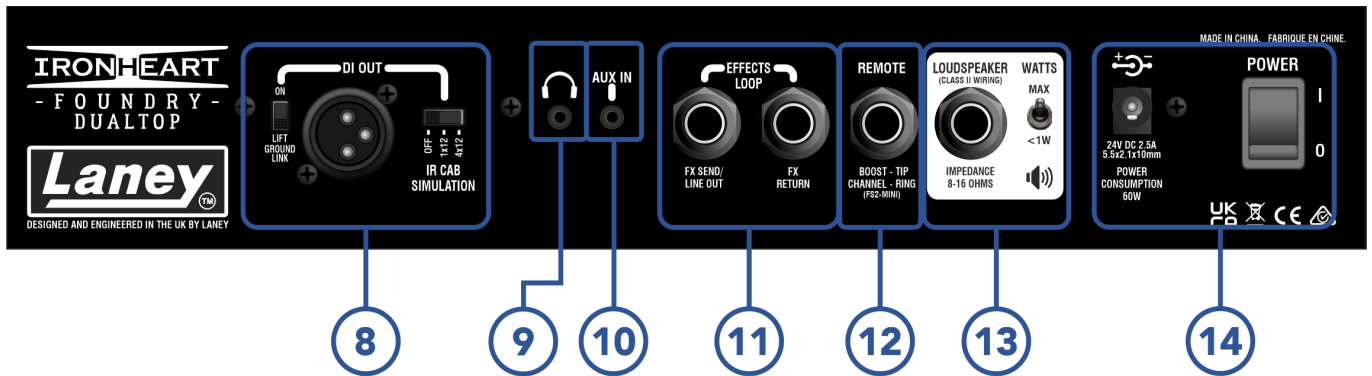

8. DI OUT

XLR output to connect to your audio interface or PA. Set the tone on the DUALTOP first then tweak your interface to get the sound you want.

- GROUND LINK - Disconnects the ground from pin 1 of the DI output ONLY. Useful to attempt to reduce ground loop hum when connected up to external devices.
- IR CAB SIMULATION - Choose between a 1x12 or 4x12 emulation added directly to your audio interface. Our own high-quality emulation will give you an authentic loudspeaker sound.

9. HEADPHONE JACK

3.5mm jack to connect your headphones for silent practice. The headphone out socket follows whichever IR cabinet emulation setting is applied for the DI out so ensure this is set for the best sound. The loudspeaker socket is muted when headphones are used.

10. AUX SOCKET

3.5mm jack to plug in any audio playing device to add a backing mix to your guitar track. This is added in after the FX loop.

11. EFFECTS LOOP

6.3mm input and output jacks.

- FX SEND / LINE OUT (TRANSFORMER ISOLATED) - A multi-purpose output that can be used as a line level output or as an FX send to your other gear such as your pedal board or rack.
- FX RETURN - Connect the output for your FX loop gear back to the DUALTOP. All the signal is sent through your external gear when connected, so inserting a jack here will break the signal path.

12. REMOTE SOCKET

6.3mm jack to plug in a footswitch to control the pre-boost function and active channel using a dual switch latching controller. The tip of the jack will control the boost, and the ring will toggle the active channel. Ensure the boost control is switched on and Channel 2 selected to allow them to be controlled. Recommended to use a Laney FS2-Mini (*not included*)

13. LOUDSPEAKER OUTPUT

Connect to any 8ohm (minimum) or 16ohm passive speaker cabinet to unleash the power of the DUALTOP.

Do NOT connect to any other gear such as an effects unit or another amplifier input.

14. POWER

Plug in the provided 100-240V~ power supply here. On/off switch to isolate the power. We suggest keeping the DUALTOP switched off when not in use. The front grille will light up to indicate the DUALTOP is powered on.

HOW TO CONNECT THE DUALTOP

INTO A PASSIVE CAB

Plug directly into a passive cabinet using the loudspeaker out socket.



WITH AN FX LOOP

Connect your effects pedalboard to the FX loop of the DUALTOP.

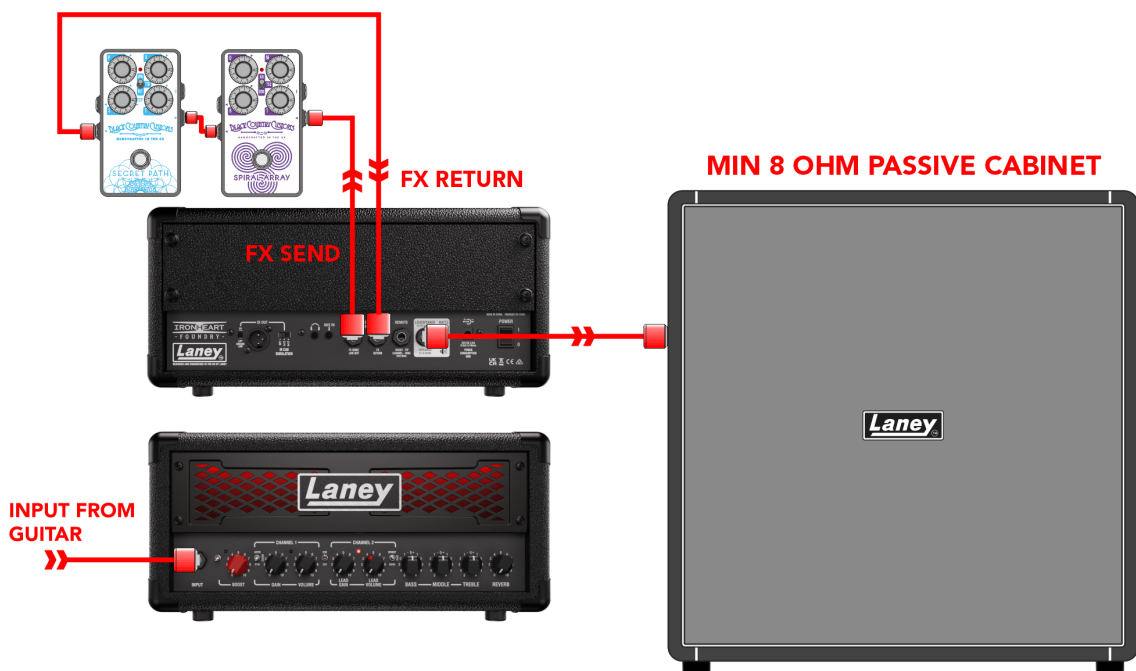

HEADPHONES AND AUX IN FOR SILENT PRACTICE

The DUALTOP's high quality headphone output can be connected for silent practice. It is optimised for high impedance headphones, commonly the 33ohm or above, though any can be used.

Add a backing track via the 3.5mm AUX connection. Plug in the aux/headphone output of any media player, control its level on your device.



USING THE DI OUT

The high quality, IR loaded, speaker emulated DI output can be connected to any balanced line level input device such as a PA or audio interface to DAW. Toggle off the cabinet emulation should you want to use your own in the DAW.

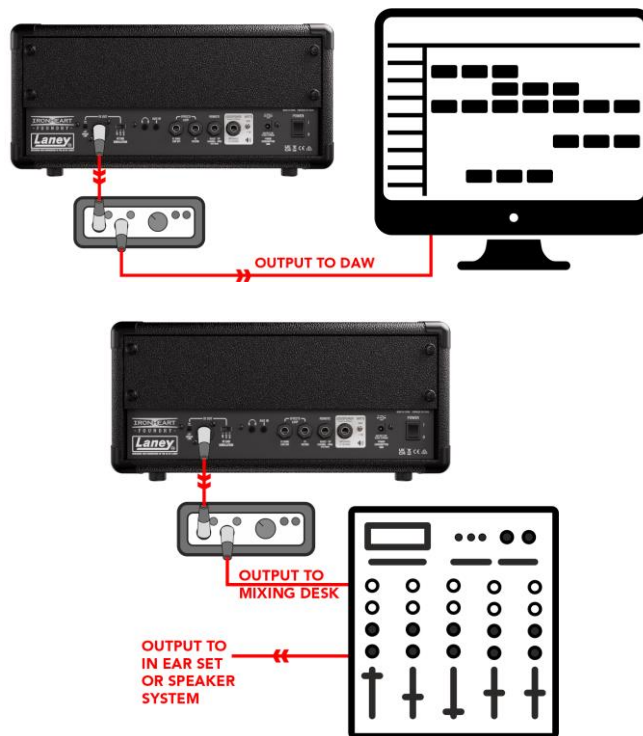

You can connect the DUALTOP to a passive cabinet as well as a PA system to use both outputs simultaneously.

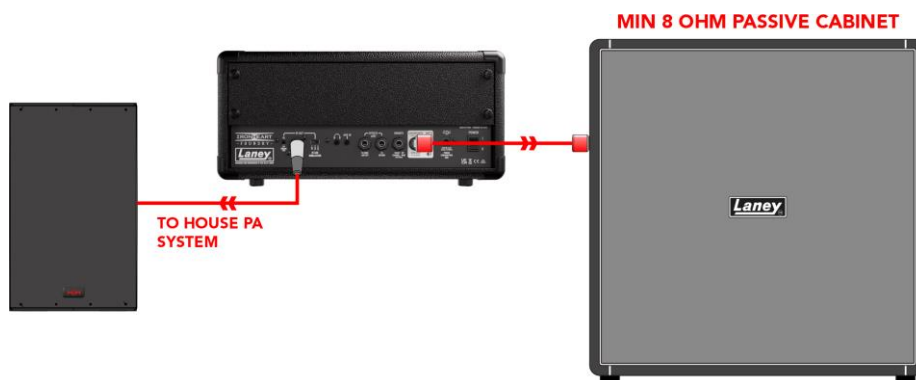

EXAMPLE SETTINGS

The best way to get started with your DUALTOP is to experiment with the controls to find your favourite sounds. However, for a head start, here are a few example tone settings to try out:

RHYTHM

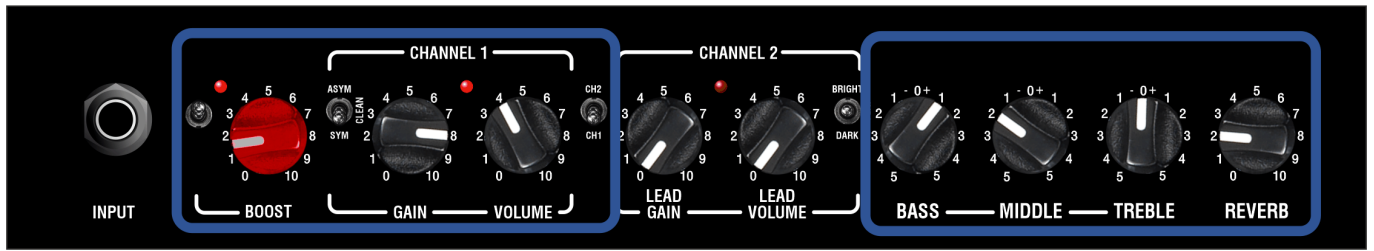

LEAD



CRUNCH



CLEAN FUNK



SPECIFICATIONS

Model	IRF-DUALTOP
Type	Guitar Amplifier Head
Input Impedance	1M Ω
Line Output Impedance	100 Ω
Minimum Speaker Impedance	8 Ω
Amplifier Power	60W RMS (Switchable to <1W)
Controls	Two Channels both with Gain and Volume. CH1 Clean, Rhythm, Lead switch. CH2 Natural, Bright, dark switch. Input pre-boost level and footswitch with LED indicator. Bass, Middle, Treble controls. Channel select footswitch with LED indication. On/Off soft start power switch, IR Based DI out emulation on/off and ground link switches
Inputs	6.3mm (1/4") Mono Instrument Input Jack, 3.5mm stereo aux in jack
Outputs	6.3mm (1/4") Mono Speaker Output Jack, 6.3mm FX Send (Transformer Isolated), 6.3mm FX Return jack, Balanced Male XLR DI out, 3.5mm stereo headphone jack
Power Supply	Regulated 24V 2.5A 60W DC PSU Included: centre Positive, 2.1 x 5.5 x 12mm connector type
Typical Power Consumption	60W
Unit dimensions (HWD)	176 x 372 x 182mm, (6.9" x 14.6" x 7.2")
Unit weight	4.5Kg, (9.9 lbs)
Carton dimensions (HWD)	220 x 505 x 230mm, (8.7" x 19.9" x 9.1") , 0.026 M3
Packed Weight	5.2Kg, (11.5 lbs)
EAN Code (Single)	5060109458527
Master Carton Dimensions (HWD)	250 x 520 x 485mm, (9.8" x 20.5" x 19.1") , 0.063 M3
Master Shipping Carton Weight	11.4Kg, (25.1 lbs)
EAN Code (Shipping)	5060109458534 (2 pcs)

DIMENSIONS (in mm)

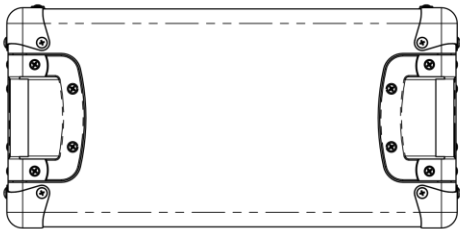
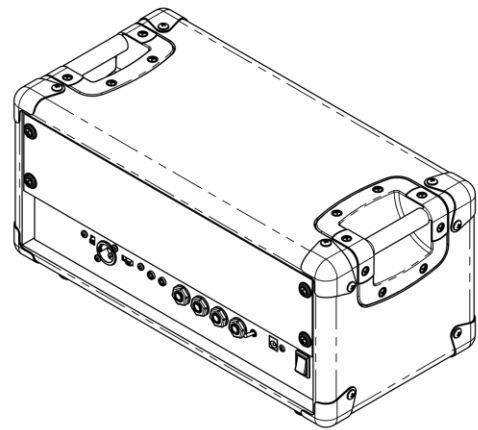
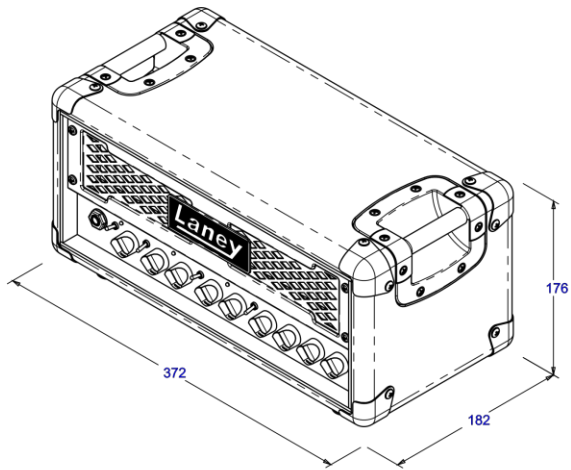

TOP

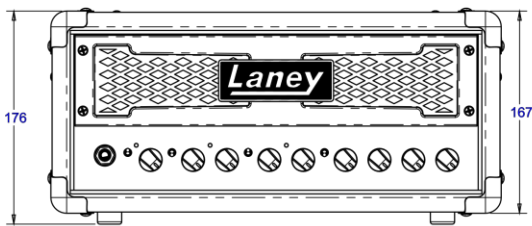

FRONT

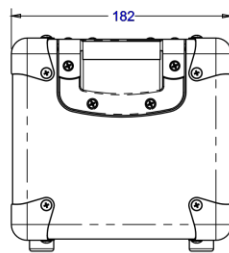

RIGHT

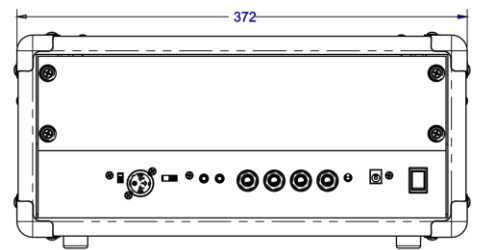

REAR





BASE





SAFETY AND WARNINGS

In order to take full advantage of your new product and enjoy long and trouble-free performance, please read this owner's manual carefully, and keep it in a safe place for future reference.

- 1) **Unpacking:** On unpacking your product please check carefully for any signs of damage that may have occurred whilst in transit from the Laney factory to your dealer. In the unlikely event that there has been damage, please re-pack your unit in its original carton and consult your dealer. We strongly advise you to keep your original transit carton, since in the unlikely event that your unit should develop a fault, you will be able to return it to you dealer for rectification securely packed.
- 2) **Amplifier Connection:** In order to avoid damage, Generally it is advisable to establish and follow a pattern for turning on and off your system. With all system parts connected, turn on source equipment, mixers, effects processors etc, BEFORE turning on your amplifier. Many products have large transient surges at turn on and off which can cause damage to your speakers. By turning on your amplifier LAST and making sure its level control is set to a minimum, any transients from other equipment should not reach your loud speakers. Wait till all system parts have stabilised, usually a couple of seconds. Similarly when turning off your system always turn down the level controls on your amplifier and then turn off its power before turning off other equipment.
- 3) **Cables:** Never use shielded or microphone cable for any speaker connections as this will not be substantial enough to handle the amplifier load and could cause damage to your complete system. Use good quality shielded cables everywhere else.
- 4) **Servicing:** The user should not attempt to service these products. Refer all servicing to qualified service personnel.
- 5) Heed all warnings.
- 6) Follow all instructions.
- 7) Do not use this apparatus near water.
- 8) Clean only with a dry cloth.
- 9) Do not block any of the ventilation openings. Install in accordance with manufacturer's instructions.
- 10) Do not install near any heat sources such as radiators, heat registers, stoves or other apparatus (including amplifiers) that produce heat.
- 11) An apparatus with Class I construction shall be connected to a mains socket outlet with a protective connection. Do not defeat the safety purpose of the polarized or grounding-type plug. A polarized plug has two blades with one wider than the other. A grounding type plug has two blades and a third grounding prong. The wide blade or third prong is provided for your safety. If the provided plug does not fit into your outlet, consult an electrician for replacement of the obsolete outlet.
- 12) Protect the power cord from being walked on or pinched, particularly at plugs, convenience receptacles, and the point they exit from the apparatus.
- 13) Only use attachments/accessories provided by the manufacturer.
- 14) Use only with a cart, stand, tripod, bracket, or table specified by the manufacturer, or sold with the apparatus. When a cart is used, use caution when moving the cart/apparatus combination to avoid injury from tip-over.
- 15) The mains plug or appliance coupler is used as the disconnect device and shall remain readily operable. The user should allow easy access to any mains plug, mains coupler and mains switch used in conjunction with this unit thus making it readily operable. Unplug this apparatus during lightning storms or when unused for long periods of time.
- 16) Refer all servicing to qualified service personnel. Servicing is required when the apparatus has been damaged in any way, such as when power-supply cord or plug is damaged, liquid has been spilled or objects have fallen into the apparatus, the apparatus has been exposed to rain or moisture, does not operate normally, or has been dropped.
- 17) Never break off the ground pin. Connect only to a power supply of the type marked on the unit adjacent to the power supply cord.
- 18) If this product is to be mounted in an equipment rack, rear support should be provided.
- 19) Note for UK only: If the colours of the wires in the mains lead of this unit do not correspond with the terminals in your plug, proceed as follows:
 - o The wire that is coloured green and yellow must be connected to the terminal that is marked by the letter E, the earth symbol, coloured green or coloured green and yellow.
 - o The wire that is coloured blue must be connected to the terminal that is marked with the letter N or the colour black.
 - o The wire that is coloured brown must be connected to the terminal that is marked with the letter L or the colour red.
- 20) This electrical apparatus should not be exposed to dripping or splashing and care should be taken not to place objects containing liquids, such as vases, upon the apparatus.
- 21) Exposure to extremely high noise levels may cause a permanent hearing loss. Individuals vary considerably in susceptibility to noise-induced hearing loss, but nearly everyone will lose some hearing if exposed to sufficiently intense noise for a sufficient time. The U.S. Government's Occupational Safety and Health Administration (OSHA) has specified the following permissible noise level exposures: According to OSHA, any exposure in excess of the above permissible limits could result in some hearing loss. Earplugs or protectors to the ear canals or over the ears must be worn when operating this amplification system in order to prevent a permanent hearing loss, if exposure is in excess of the limits as set forth above. To ensure against potentially dangerous exposure to high sound pressure levels, it is recommended that all persons exposed to equipment capable of producing high sound pressure levels such as this amplification system be protected by hearing protectors while this unit is in operation.

Duration Per Day in Hours	Sound Level dBA, slow response
8	90
6	92
4	95
3	97
2	100
1 1/2	102
1	105
1/2	110
1/4 ou inférieur	115
- 22) If your appliance features a tilting mechanism or a kickback style cabinet, please use this design feature with caution. Due to the ease with which the amplifier can be moved between straight and tilted back positions, only use the amplifier on a level, stable surface. DO NOT operate the amplifier on a desk, table, shelf or otherwise unsuitable non-stable platform.
- 23) Symbols & nomenclature used on the product and in the product manuals, intended to alert the operator to areas where extra caution may be necessary, are as follows:

 CAUTION:	<p>Intended to alert the user to the presence of uninsulated 'Dangerous Voltage' within the products enclosure that may be sufficient to constitute a risk of electrical shock to persons.</p> <p>Ce symbole est utilise pur indiquer a l'utilisateur de ce produit de tension non-isolee dangereuse pouvant etre d'intensite suffisante pour constituer un risque de choc electrique.</p> <p>Este simbolo tiene el proposito de alertar al usuario de la presencia de '(voltaje) peligroso' que no tiene aislamiento dentro de la caja del producto que puede tener una magnitud suficiente como para constituir riesgo de corrientazo.</p> <p>Dieses Symbol soll den Anwender vor unisolierten gefahrlichen Spannungen innerhalb des Gehauses warnen, die von Ausreichender Starke sind, um einen elektrischen Schlag verursachen zu konnen.</p>
 WARNING:	<p>Intended to alert the user of the presence of important operating and maintenance (Servicing) instructions in the literature accompanying the product.</p> <p>Dieses Symbol soll den Anwender vor unisolierten gefahrlichen Spannungen innerhalb des Gehauses warnen, die von Ausreichender Starke sind, um einen elektrischen Schlag verursachen zu konnen.</p>

	<p>Este simbolo tiene el proposito de la alertar al usuario de la presencis de instrucccones importantes sobre la operacion y mantenimiento en la literatura que viene conel producto.</p> <p>Dieses Symbol soll den Benutzer auf wichtige Instruktionen in der Bedienungsanleitung aufmerksam machen, die Handhabung und Wartung des Produkts betreffen.</p>
CAUTION:	Risk of electrical shock - DO NOT OPEN. To reduce the risk of electrical shock, do not remove the cover. No user serviceable parts inside. Refer servicing to qualified personnel.
ATTENTION:	Risques de choc electrique - NE PAS OUVIRIR. Afin de reduire le risque de choc electrique, ne pas enlever le couvercle. Il ne se trouve a l'interieur aucune piece pouvant etre reparee par l'utilisateur. Confier l'entretien a un personnel qualifie.
PRECAUCION:	Riesgo de corrientazo - no abra. Para disminuir el risego de corrientazo, no abra la cubierta. No hay piezas adentro que el pueda reparar. Deje todo mantenimiento a los tecnicos calificadod.
VORSICHT:	Risiko - Elektrischer Schlag! Nicht offen! Um das Risiko eines elektrischen Schlages zu vermeiden, nicht die Abdeckung entfernen. Es befinden sich keine Teile darin, die vow Anwender repariert werden Konnten. Reparaturen nur von qualifiziertem Fachpersonal durchfuhren lassen.
WARNING:	To prevent electrical shock or fire hazard, do not expose this appliance to rain or moisture. Before using this appliance please read the operating instructions for further warnings.
ADVERTISSEMENT:	Afin de prevenir les risques de decharge electrique ou de feu, n'exposez pas cet appareil a la pluie ou a l'humidite. Avant d'utiliser cet appareil, lisez les advertissements supplentaires situes dans le guide.
ADVERTENCIA:	Para evitar corrientazos o peligro de incendio, no deja expuesto a la lluvia o humedad este aparato Antes de usar este aparato, lea mas advertcias en la guia de operacion.
ACHTUNG:	Um einen elektrischen Schalg oder Feuergefahr zu vermeiden, sollte dieses Gerat nicht dem Regen oder Feuchtigkeit ausgesetzt werden. Vor Inbetriebnahme unbedingt die Bedienungsanleitung lesen.
	<p>This device complies with Part 15 of the FCC rules Operation is subject to the following two conditions:</p> <ol style="list-style-type: none"> 1) This device may not cause harmful interference 2) This device must accept any interference received, that may cause undesired operation. <p>Warning: Changes or modification to the equipment not approved by Laney can void the user's authority to use the equipment.</p> <p>Note: This equipment has been tested and found to comply with the limits for Class B digital device, pursuant to Part 15 of the FCC Rules. These limits are designed to provide reasonable protection against harmful interference in a residential installation. This equipment generates, uses and can radiate radio frequency energy and if not installed and used in accordance with the instructions, may cause harmful interference to radio communications. However, there is no guarantee that interference will not occur in a particular installation. If this equipment does cause harmful interference to radio or television reception, which can be determined by turning the equipment off and on, the user is encouraged to try and correct the interference by one or more of the following measures. Reorient or relocate the receiving antenna. Increase the separation between the equipment and receiver. Connect the equipment into an outlet on a circuit different from that to which the receiver is connected. Consult the dealer or an experienced radio/TV technician for help.</p>
	<p>This product conforms to the requirements of the following European Regulations, Directives & Rules: CE Mark (93/68/EEC), Low Voltage (2014/35/EU), EMC (2014/30/EU), RoHS (2011/65/EU), ErP (2009/125/EU)</p> <p>SIMPLIFIED EU DECLARATION OF CONFORMITY</p> <p>Hereby, Laney Electronics Ltd. declares that the radio equipment is in compliance with Directives 2014/53/EU, 2011/65/EU, 2009/125/EU. Full text of the EU declaration of conformity is available at the following internet address:</p> <p>http://support.laney.co.uk/approvals</p>
	<p>The object of the declaration described above is in conformity with the relevant statutory requirement Electrical Equipment (Safety) Regulations 2016, Electromagnetic Compatibility Regulations 2016, The Restriction of the use of Certain Hazardous Substances in Electrical and Electronic Equipment Regulations 2012, The Ecodesign for Energy-Related Products and Energy Information, (Amendment) (EU Exit) Regulations 2012</p>
	<p>In order to reduce environmental damage, at the end of its useful life, this product must not be disposed of along with normal household waste to landfill sites. It must be taken to an approved recycling centre according to the recommendations of the WEEE (Waste Electrical and Electronic Equipment) directive applicable in your country.</p>

IRONHEART

- F O U N D R Y -



STEELPARK ROAD, COOMBSWOOD BUSINESS PARK WEST, HALESOWEN, B62 8HD. UK
FOR THE LATEST INFORMATION PLEASE VISIT WWW.LANEY.CO.UK

IN THE INTEREST OF CONTINUED DEVELOPMENT, LANEY RESERVES THE RIGHT TO AMEND PRODUCT SPECIFICATION WITHOUT PRIOR NOTIFICATION.

V0.9

