

**IRONHEART**



# BCC-IRT60H/IRT120H USER MANUAL

**Laney**<sup>TM</sup>

## CONTENTS

INTRODUCTION .....	2
FEATURES .....	3
CONTROLS .....	4
FRONT PANEL .....	4
REAR PANEL .....	7
HOW TO CONNECT BCC-IRT60H/120H .....	9
INTO A PASSIVE CAB .....	9
WITH AN FX LOOP .....	9
USING THE D.I. OUT .....	10
EXAMPLE SETTINGS.....	11
CLEAN .....	11
ROCK .....	11
METAL .....	11
DETUNED METAL .....	11
JAZZ.....	11
BLUES .....	11
BLOCK DIAGRAM .....	12
SPECIFICATIONS .....	13
DIMENSIONS (in mm).....	14
SAFETY AND WARNINGS .....	15



## INTRODUCTION

Since its launch in 2012 the IRONHEART range has been a consistent and much-loved member of the Laney amp family. So it is with great happiness that we are pleased to announce that one of our most successful tube amp ranges has been brought back home to where it was created. The BCC-IRONHEART range is now manufactured in the UK. With all the hands-on attention to detail that players expect for a top-class hand-built, all tube amplifier.

Designed and dedicated to delivering the best tube tone possible for even the most critical of hungry tone hounds.

Meticulously handcrafted in our UK workshop, the Black Country Customs tube amps that have built up an outstanding reputation as a modern sounding high gain tone powerhouse. Packed full of features making them extremely versatile and aggressive sounding amplifier. The "built in the UK" BCC-IRONHEARTS benefit from some under the hood upgrades, such as an updated PRE-BOOST circuit which is optimised to reduce low-end muddiness even when massive amounts of gain are dialled in. Tightening up the amps chug and producing a smoother clipping curve.

Featuring a full 3-channel pre-amp with clean, rhythm and lead channels, plus a footswitchable pre-boost section, the BCC-IRONHEARTS also features a vari-watts control, which allows you to get the great guitar tone you are after at any wattage level without compromising your tone, ever.

New enhanced boost circuitry on the UK built BCC-IRONHEARTS allows you to drive the amps hard without any of the muddiness and uncontrollable low end associated with lesser amps.

The BCC-IRONHEART heads are fitted with a full set of speaker socket options allowing you to match it with whatever cabinet you choose as well as a truly awesome sounding cabinet emulated DI out that allows you to connect your BCC-IRONHEART directly to the PA - removing the need to mic your cabinet and giving the engineer a great consistent sound every time. The source of the DI signal can be switched allowing you to get a great recording sound using your favourite IR within your DAW. Combine these features with an effects loop with level switching, an AUX in and the ability to select either 6L6 or EL34 output valve type and you have a great sounding, super flexible high gain all valve tone machine. Capable of satisfying even the most demanding of tone conscious players.

Lovingly handcrafted in our UK workshop, our IRONHEARTs are Forged in Iron!



## FEATURES

- High Power All tube heads, featuring four ECC83 preamp tubes and either two or four 6L6 Power tubes
- Full 60 Watts RMS (BCC-IRT60H) or 120 Watts RMS (BCC-IRT120H)
- 3 Independent Channels
  - CH1 - Clean
  - CH2 - Rhythm, with Gain, Volume and passive 3 band Tone stack
  - CH3 - Lead, with Gain, Volume and passive 3 band Tone stack
- Switchable Pre-boost with level control
- Digital Spring line reverb
- Dynamics Control for Low end control
- Master Tone Control
- Watts control for accurate power reduction and control
- DI output with Level control and source select and ground link switch
- Loudspeaker out (4-16 $\Omega$ )
- Effects loop with switchable bypass, 0dbu or -10dbu level settings.
- Robust 4W footswitch included
- Aux in



# CONTROLS

## FRONT PANEL



### 1. INPUT SOCKET

Plug in the input jack from your guitar here, suits any standard 6.3mm mono jack.

### 2. PRE-BOOST CONTROL

The switchable and variable PRE-BOOST control is an additional gain setting to increase the input signal to the preamp tubes, just like placing a boost pedal in the signal path. This drives the preamp tubes harder, resulting in more distortion and works on both channels. It's especially pleasing when used to push the clean channel into slight breakup.

### 3. LEAD GAIN

Controls the level of preamp gain on the Lead channel. Turning this control clockwise will add more distortion to your guitar signal, ranging from light overdrive, to full on metal. Use this in conjunction with Lead Volume (6) to achieve the correct volume and distortion level you require.

### 4. LEAD EQ CONTROLS - CONTROLS PUSHED

A traditional three band set of variable passive tone controls providing control in the BASS, MIDDLE and TREBLE frequency bands. Due to their unique interactive nature, the controls provide the player a more natural set of tools to shape their ideal sound. As a good starting point, set the controls to midway (0).

### 5. LEAD EQ CONTROLS - CONTROLS PULLED

Pulling on each of the EQ control knobs will shift the response of each control as follows:

- BASS - Deep - This extends the low-end frequency response, resulting in a fuller, heavier sound for lower notes.
- MIDDLE - Shift - This lowers the frequency range of the MIDDLE control to give a tighter sound.
- TREBLE -Shift - This broadens the TREBLE control frequency response, to give a rounder sound to higher notes, especially when used with thin sounding pickups.



## 6. LEAD VOLUME

Controls the Lead channel volume. Experiment with different combinations of the GAIN and VOLUME controls to achieve different sounds. Reducing the GAIN while increasing the VOLUME will result in a warm, open, overdriven sound as the power amp is driven harder, while reducing the VOLUME and increasing the GAIN will give a tighter, more modern sound with more distortion. Once set, try using your guitar's volume controls to interactively adjust tone and distortion levels.

## 7. CHANNEL SWITCH

Switches between the LEAD and CLEAN/RHYTHM channels with status LED's to see the current state at a glance.

## 8. CLEAN/RHYTHM SWITCH & CLEAN VOLUME

This switch activates the CLEAN mode on the RHYTHM channel. When operated, the CLEAN VOLUME control becomes active, while RHYTHM GAIN (9) and RHYTHM VOLUME (12) are removed from the signal path. When using CLEAN mode, the preamp gain is lowered, resulting in a cleaner tone. In CLEAN mode, the green LED to the right of the CLEAN VOLUME control illuminates.

In RHYTHM mode the CLEAN VOLUME control is disabled with the RHYTHM GAIN (9) and RHYTHM VOLUME (12) taking control of the channel. The green LED to the right of the CLEAN VOLUME control turns off.

## 9. RHYTHM GAIN

See LEAD GAIN (3)

## 10. RHYTHM EQ CONTROLS - CONTROLS PUSHED

See LEAD EQ CONTROLS (4)

## 11. RHYTHM EQ CONTROLS - CONTROLS PULLED

See LEAD EQ CONTROLS (5)

## 12. RHYTHM VOLUME

See Lead Volume (6)

## 13. DYNAMICS

This allows control over the response of the amplifier at lower frequencies. Turning this control clockwise gives a looser low end, while lower settings provide a tighter response with the optimal setting dependant on the speaker cabinet used.

## 14. TONE

The TONE control works in a similar fashion to the Tone control you probably have on your guitar except that it uniquely works at the other end of the amplification chain. This has the ability to not only control the overall top end response, but also reduce upper harmonics on the output stage and preamplifier overdrive sounds. This will give you bright cutting sounds at high settings and smooth rounded sounds at lower settings. Midway (0) is a good starting point. The sonic outcome when using the TONE and DYNAMICS controls depend greatly on the speaker cabinet connected to the amplifier.



### **15. REVERB**

Controls the level of the built in Laney-designed digital reverb.

### **16. WATTS**

The WATTS acts like an overall Volume control for the amplifier, allowing the user to retain similar tonal qualities, unique to a valve amplifier, but at reduced output levels, ideal in a practice environment. Full output power is achieved with the WATTS control fully clockwise and will run the power tubes at maximum level. Reduced overall output volume is achieved by turning the WATTS control anticlockwise.

### **17. STANDBY SWITCH and STATUS LAMP**

Internally disconnects the main HT voltage from the tubes but keeps the tubes warm so that they are ready to play instantly. Switch for short breaks when you don't want to wait for the tubes to warm up again. With the switch in the 1 (up) position, the amp is in play mode, while 0 (down) allows the amp to warm up. The STANDBY LAMP will illuminate when the amplifier is in play mode.

### **18. POWER SWITCH and LAMP**

Main power switch for the unit. Tube amplifiers take between 30 seconds to 2 minutes to warm up and be ready to play after switching on, this is normal. Use in conjunction with the standby switch to prolong tube life. To turn on, flip the switch to 1 (up), the POWER lamp will illuminate.



## REAR PANEL

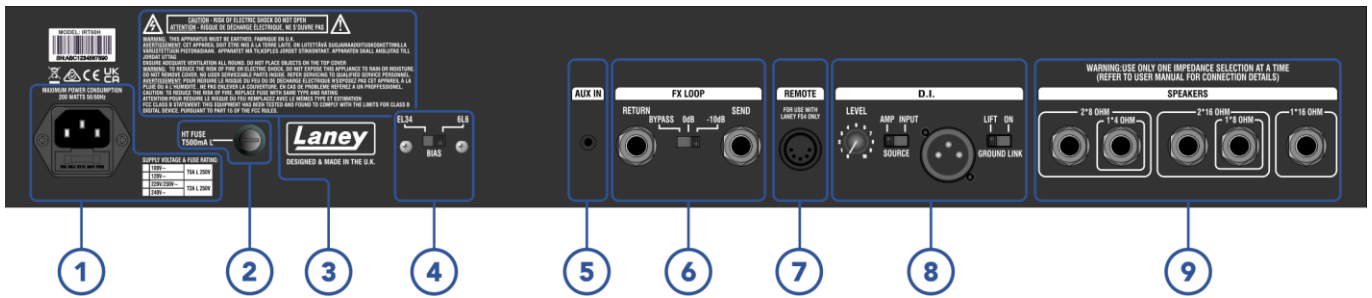

### 1. MAINS INLET and FUSE

Make sure the voltage indicated on the rear panel is correct for your country! This drawer contains the main safety fuse for the unit. The fuse protects the amplifier from damage in the event of fault by disconnecting the mains power supply. **USE ONLY THE CORRECT SIZE AND RATING SPECIFIED ON THE REAR PANEL**, also detailed in the Specifications table of this manual. If a fuse blows or fails and a replacement of the same size and rating is installed which in turn blows, the amplifier has suffered a malfunction and needs immediate service from a qualified technician. **DO NOT TRY A FUSE OF A HIGHER RATING** - Using a fuse that is too large in current rating may cause serious, irreparable damage to the amplifier and presents a serious fire hazard. There is a spare fuse located in the fuse drawer of the mains power inlet in the event of a failure. This unit must be earthed under all circumstances!

### 2. HT FUSE

This fuse disconnects the high voltage DC power to the tubes within the amplifier in the event of a fault. **USE ONLY THE CORRECT SIZE AND RATING FUSE AS SPECIFIED ON THE PANEL**. If a fuse blows or fails and a replacement of the same size and rating is installed which in turn blows, the amplifier has suffered a malfunction. At this point check the output tubes and replace faulty ones if required. Should the tubes not be the problem, refer the amplifier to a qualified service technician. **DO NOT TRY A FUSE OF HIGHER RATING** - Using a fuse that is too large in current rating may cause serious, irreparable damage to the amplifier. Fuses are designed to protect, do not take chances.

### 3. SAFETY WARNINGS

Take note of the safety information on the rear panel.

### 4. BIAS SWITCH

The IRT120H is factory fitted with 4x matched 6L6 tubes, while the IRT60H features 2x matched 6L6 tubes. This switch allows the use of EL34 output tubes in your amplifier instead. Ensure that the switch is in the correct position for your output tubes, otherwise you may risk damaging your amplifier. We recommend the use of matched sets of output tubes for optimum performance.

### 5. AUXILIARY INPUT

This input allows the connection of backing tracks etc. to be mixed in post the FX loop.



## 6. FX LOOP

### a. FX RETURN

A 1/4" mono jack socket for the connection of the output of an external FX unit. This can also be used as a slave in for the power amp. As the FX Loop is an insert type, the preamp signal will be muted.

The FX LOOP SWITCH selects the FX Loop mode of operation:

- Bypass - Removes the FX Loop from the signal path.
- 0dBu - For connection of FX units with a 0dBu nominal output level.
- -10dBu - For connection of FX units with a -10dBu nominal output level. As this is intended for devices with a lower output level, this switch increases the gain of the FX Loop by 10dB.

### b. FX SEND

A 1/4" mono jack socket for connection to the input of an external FX unit. This can also be used as a line out for connection to another power amp slave input or for recording.

## 7. FOOTSWITCH REMOTE

Connect the included FS4 FOOTSWITCH using the supplied 5 pin DIN cable. This will provide the user with remote operation of the following functions: CHANNEL, CLEAN, REVERB, AND BOOST.

## 8. D.I.

A Balanced output with dedicated LEVEL control for connection to an external device. Some examples include house PA, recording setup, stage monitor system.

In the unlikely event of ground hum when connecting to other equipment, simply disengage the D.I. GROUND LINK.

The D.I. signal is sourced from one of two places:

INPUT - A buffered signal picked up from the input of the amplifier. The signal doesn't include speaker emulation.

AMP - In this mode, the signal is sourced from the output of the amplifier and includes additional 4\*12 speaker emulation.

## 9. SPEAKER OUTPUTS

Five 1/4" mono jack sockets are provided for the connection of a variety of speaker cabinets. The Laney GS range of cabinets (including the GS112FE / GS212FE / GS412IA and GS412IS) are recommended for use with the BCC-IRT Heads. Always ensure you use the correct impedance socket to match your chosen cabinet/s total impedance.

Mismatching your speaker impedance will reduce the performance of your amplifier, and in extreme cases may damage the unit.

Always operate this amplifier with a load connected. Failure to do so could result in serious irreparable damage to the unit!



# HOW TO CONNECT BCC-IRT60H/120H

## INTO A PASSIVE CAB

Plug directly into a passive cabinet using the 4 Ω loudspeaker output.

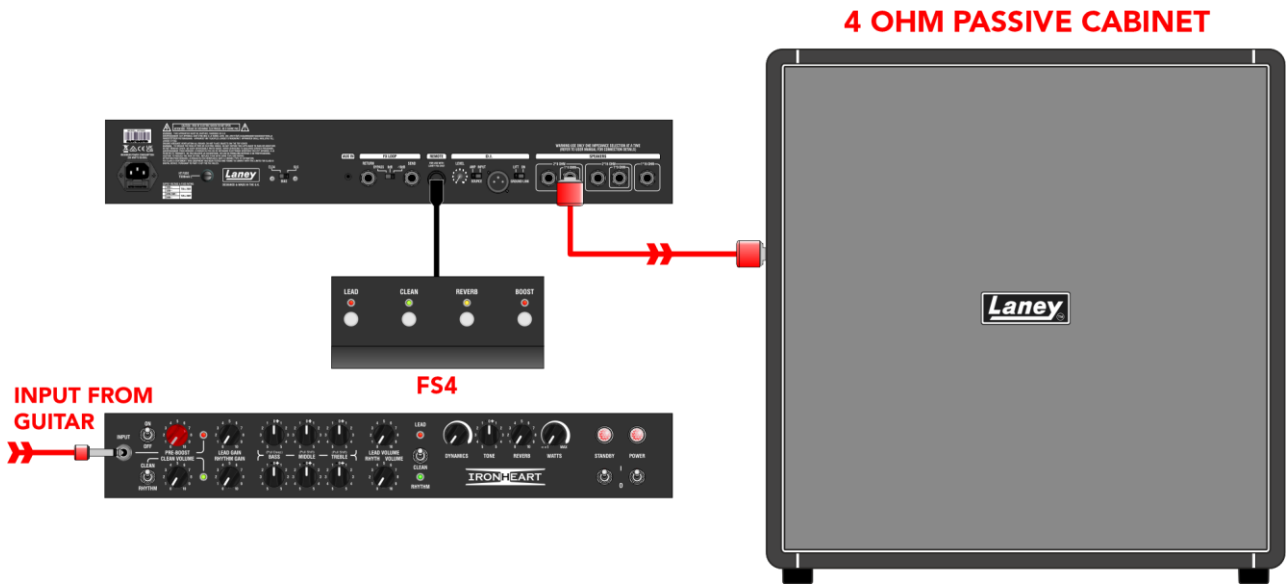

## WITH AN FX LOOP

Connect your effects pedalboard to the FX loop with the FX loop FX Loop level set to 0dB. In this example the 8 Ω loudspeaker output is used.

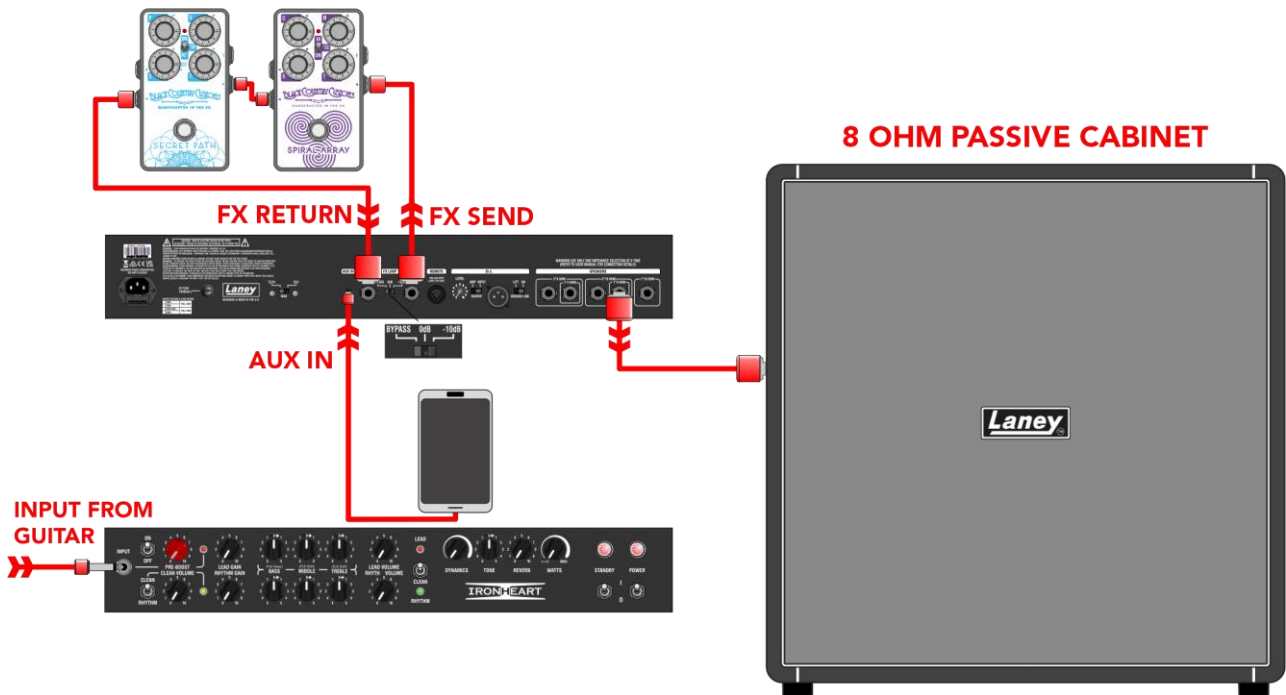

## USING THE D.I. OUT

The high quality, IR loaded, speaker emulated D.I. output can be connected to any balanced/unbalanced line level input device such as a PA or audio interface to DAW. Toggle off the cabinet emulation should you want to use your own in the DAW. In the examples below the SPEAKER outputs must be connected to a suitable cabinet or speaker load box. If not, serious damage to the amplifier will occur!

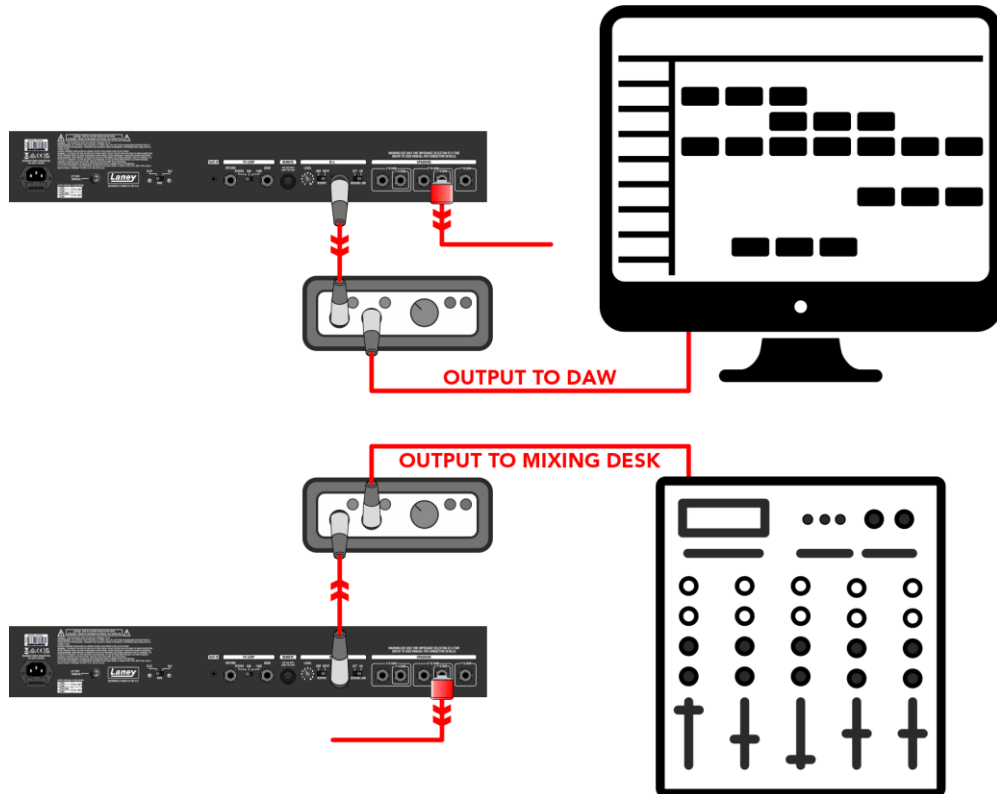

You can connect the BCC-IRT HEAD to a passive cabinet, in this case a 16 Ω as well as a PA system to use both outputs simultaneously.

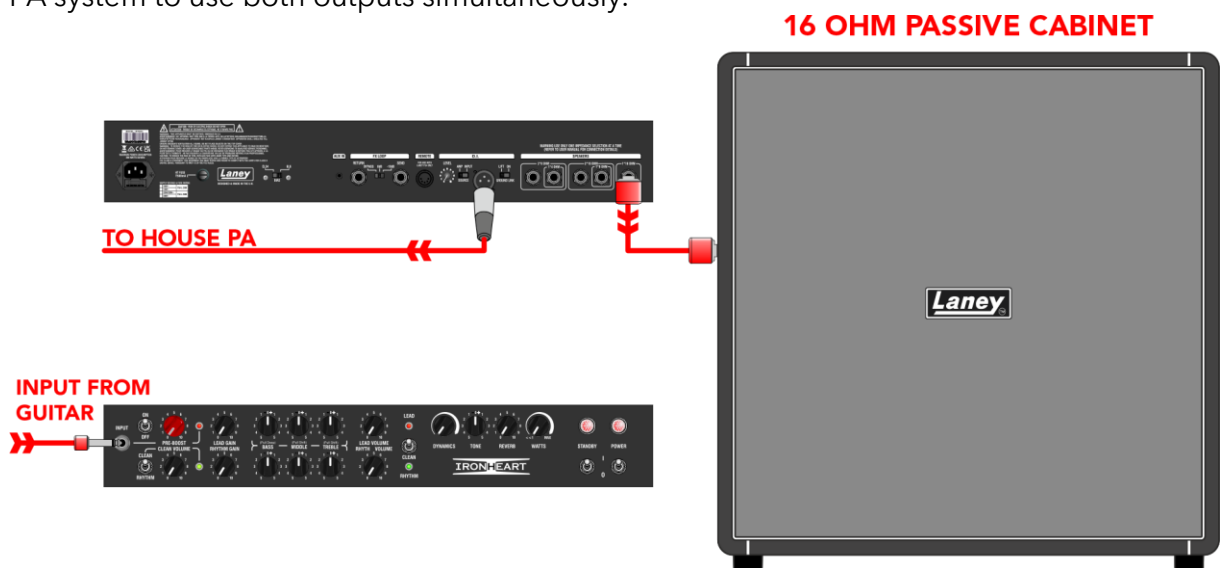

## EXAMPLE SETTINGS

The best way to get started with your BCC-IRT HEAD is to experiment with the controls to find your favourite sounds. However, for a head start, here are a few example tone settings to try out:

### CLEAN



### ROCK



### METAL



### DETUNED METAL



### JAZZ



### BLUES



# BLOCK DIAGRAM

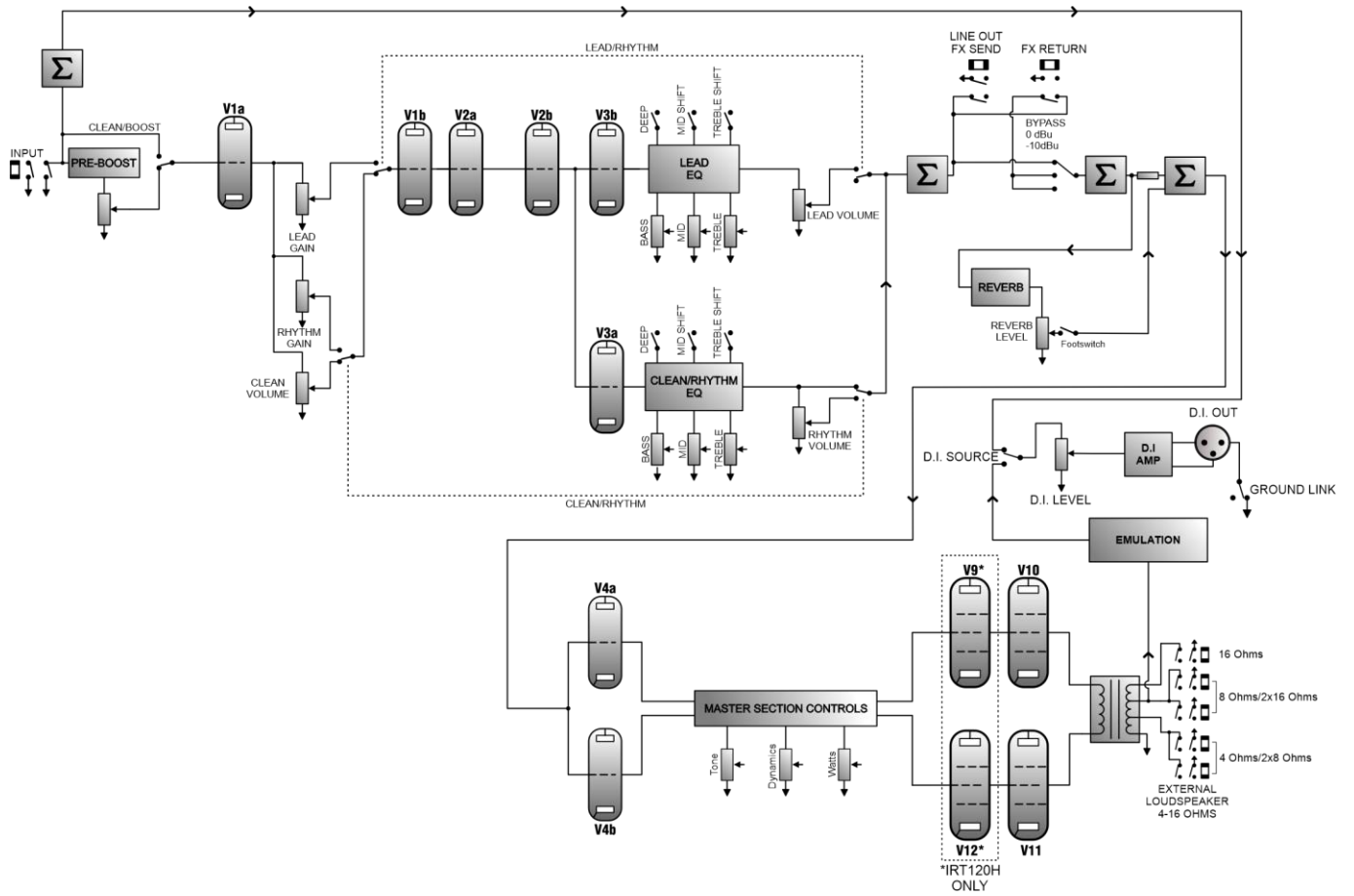

## SPECIFICATIONS

MODEL	BCC-IRT60H	BCC-IRT120H
SUPPLY VOLTAGE	~100V, ~120V, ~220V, ~240V 50/60Hz	
MAINS FUSE (FACTORY PRESET)	~100V/~120V: T5A L 250V ~220V/~230V/250V: T2A L 250V	
HT FUSE	T500mA L	T1A L
POWER CONSUMPTION	200 Watts	300 Watts
OUTPUT POWER RATING	60 Watts	120 Watts
LOUDSPEAKER OUTPUTS (SPEAKER IMPEDANCE)	4 Ω, 8 Ω, or 16 Ω	
VALVES	4 x 12AX7/ECC83 preamp tubes and 2 x 6L6 output tubes	4 x 12AX7/ECC83 preamp tubes and 4 x 6L6 output tubes
INPUT IMPEDANCE	1MΩ	
INPUTS	6.3mm (1/4") Mono Instrument Input Jack 3.5mm stereo AUX IN jack	
CONTROLS	Variable PRE-BOOST Control with LED indicator - Toggle and foot switchable Channel selection - LEAD / CLEAN/RHYTHM with LED indicator - Toggle and foot switchable CLEAN/RHYTHM selection with LED indicator - Toggle and foot switchable Two Channels both with GAIN, switchable 3 Band EQ and VOLUME DYNAMICS, TONE, foot switchable REVERB and WATTS control	
OUTPUTS	6.3mm FX Send jack, 6.3mm FX Return jack Balanced Male XLR D.I. out with LEVEL control, SOURCE Selection and GROUND LINK 5 x 6.3mm (1/4") Mono Speaker Output jack	
FOOTSWITCH (INCLUDED)	1x 5 pin DIN terminated FS4 footswitch for control of BOOST, CLEAN, CHANNEL and REVERB	
UNIT DIMENSIONS (HWD)	271 x 678 x 288mm, (10.7" x 26.7" x 11.3")	271 x 678 x 288mm, (10.7" x 26.7" x 11.3")
UNIT WEIGHT	20Kg, (44.1 lbs)	23Kg, (50.7 lbs)
CARTON DIMENSIONS (HWD)	370 x 850 x 385mm, (14.6" x 33.5" x 15.2")	370 x 850 x 385mm, (14.6" x 33.5" x 15.2")
PACKED WEIGHT	24Kg, (53.0 lbs)	27.5Kg, (60.6 lbs)
EAN CODE (SINGLE)	5060109458763	5060109458770



**DIMENSIONS (in mm)**

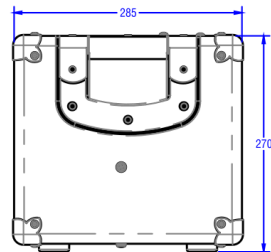
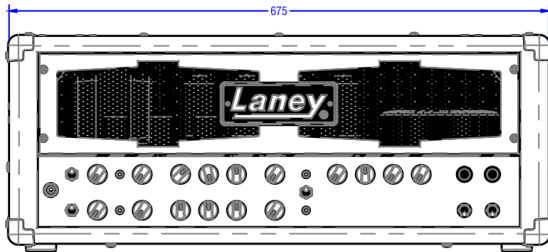
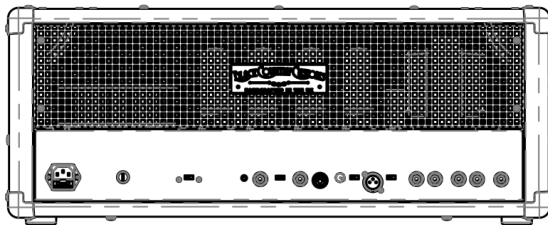
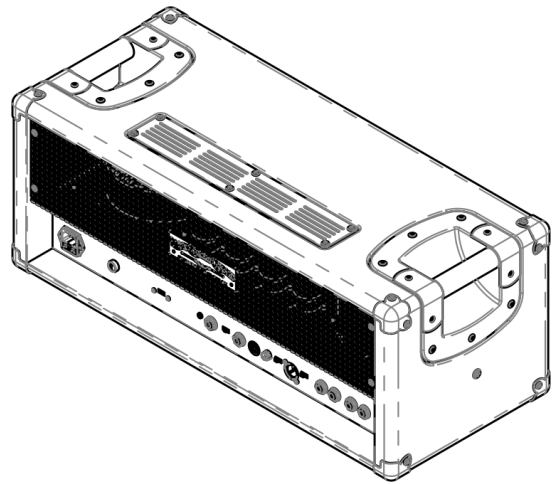
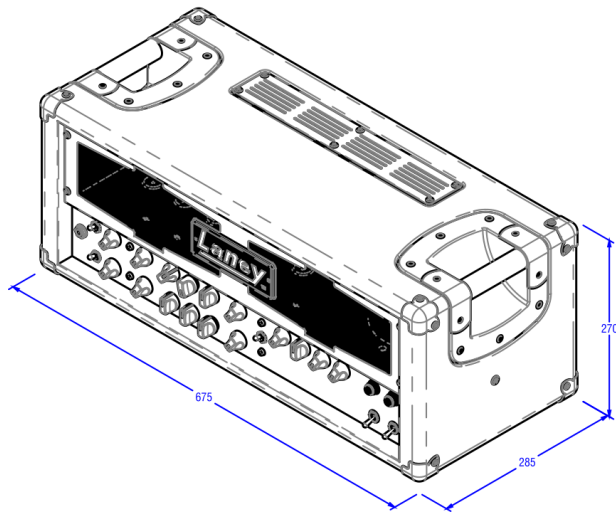

## SAFETY AND WARNINGS







MANUFACTURER: HEADSTOCK DISTRIBUTION LTD. STEELPARK ROAD,  
COOMBS WOOD BUSINESS PARK WEST, HALESOWEN, B62 8HD, UK

To take full advantage of your new product and enjoy long and trouble-free performance, please read this owner's manual carefully, and keep it in a safe place for future reference.

- 1) **Unpacking:** On unpacking your product, please check carefully for any signs of damage that may have occurred whilst in transit from the Laney factory to your dealer. In the unlikely event that there has been damage, please re-pack your unit in its original carton and consult your dealer. We strongly advise you to keep your original transit carton, since in the unlikely event that your unit should develop a fault, you will be able to return it to your dealer for rectification securely packed.
- 2) **Amplifier Connection:** To avoid damage, generally it is advisable to establish and follow a pattern for turning on and off your system. With all system parts connected, turn on source equipment, mixers, effects processors etc, BEFORE turning on your amplifier. Many products have large transient surges at turn on and off which can cause damage to your speakers. By turning on your amplifier LAST and making sure its level control is set to a minimum, any transients from other equipment should not reach your loudspeakers. Wait till all system parts have stabilised, usually a couple of seconds. Similarly, when turning off your system always turn down the level controls on your amplifier and then turn off its power before turning off other equipment.
- 3) **Cables:** Never use shielded or microphone cable for any speaker connections as this will not be substantial enough to handle the amplifier load and could cause damage to your complete system. Use good quality shielded cables everywhere else.
- 4) **Servicing:** The user should not attempt to service these products. Refer all servicing to qualified service personnel.
- 5) Heed all warnings.
- 6) Follow all instructions.
- 7) Do not use this apparatus near water.
- 8) Clean only with a dry cloth.
- 9) Do not block any of the ventilation openings. Install in accordance with manufacturer's instructions.
- 10) Do not install near any heat sources such as radiators, heat registers, stoves, or other apparatus (including amplifiers) that produce heat.
- 11) An apparatus with Class I construction shall be connected to a mains socket outlet with a protective connection. Do not defeat the safety purpose of the polarized or grounding-type plug. A polarized plug has two blades with one wider than the other. A grounding type plug has two blades and a third grounding prong. The wide blade or third prong is provided for your safety. If the provided plug does not fit into your outlet, consult an electrician for replacement of the obsolete outlet.
- 12) Protect the power cord from being walked on or pinched, particularly at plugs, convenience receptacles, and the point they exit from the apparatus.
- 13) Only use attachments/accessories provided by the manufacturer.
- 14) Use only with a cart, stand, tripod, bracket, or table specified by the manufacturer, or sold with the apparatus. When a cart is used, use caution when moving the cart/apparatus combination to avoid injury from tip-over.
- 15) The mains plug or appliance coupler is used as the disconnect device and shall remain readily operable. The user should allow easy access to any mains plug, mains coupler and mains switch used in conjunction with this unit thus making it readily operable. Unplug this apparatus during lightning storms or when unused for long periods of time.
- 16) Refer all servicing to qualified service personnel. Servicing is required when the apparatus has been damaged in any way, such as when power-supply cord or plug is damaged, liquid has been spilled or objects have fallen into the apparatus, the apparatus has been exposed to rain or moisture, does not operate normally, or has been dropped.
- 17) Never break off the ground pin. Connect only to a power supply of the type marked on the unit adjacent to the power supply cord.
- 18) If this product is to be mounted in an equipment rack, rear support should be provided.
- 19) Note for UK only: If the colours of the wires in the mains lead of this unit do not correspond with the terminals in your plug, proceed as follows:
  - o The wire that is coloured green and yellow must be connected to the terminal that is marked by the letter E, the earth symbol, coloured green or coloured green and yellow.
  - o The wire that is coloured blue must be connected to the terminal that is marked with the letter N or the colour black.
  - o The wire that is coloured brown must be connected to the terminal that is marked with the letter L or the colour red.
- 20) This electrical apparatus should not be exposed to dripping or splashing and care should be taken not to place objects containing liquids, such as vases, upon the apparatus.
- 21) Exposure to extremely high noise levels may cause a permanent hearing loss. Individuals vary considerably in susceptibility to noise-induced hearing loss, but nearly everyone will lose some hearing if exposed to sufficiently intense noise for a sufficient time. The U.S. Government's Occupational Safety and Health Administration (OSHA) has specified the following permissible noise level exposures: According to OSHA, any exposure more than the above permissible limits could result in some hearing loss. Earplugs or protectors to the ear canals or over the ears must be worn when operating this amplification system to prevent a permanent hearing loss, if exposure is more than the limits as set forth above. To ensure against potentially dangerous exposure to high sound pressure levels, it is recommended that all persons exposed to equipment capable of producing high sound pressure levels such as this amplification system be protected by hearing protectors while this unit is in operation. In the EU, exposure is regulated under Directive 2003/10/EC. Prolonged exposure above 85 dB(A) can cause hearing damage. Hearing protection must be used when operating equipment capable of producing high sound pressure levels.

Duration Per Day in Hours	Sound Level dBA, slow response
8	90
6	92
4	95
3	97
2	100
1 1/2	102
1	105
1/2	110
1/4 ou inférieur	115



 <b>CAUTION:</b>	<p>Intended to alert the user to the presence of uninsulated 'Dangerous Voltage' within the products enclosure that may be sufficient to constitute a risk of electrical shock to persons.</p> <p>Ce symbole est utilisé pur indiquer a l'utilisateur de ce produit de tension non-isolée dangereuse pouvant être d'intensité suffisante pour constituer un risque de choc électrique.</p> <p>Este símbolo tiene el propósito de alertar al usuario de la presencia de '(voltaje) peligroso' que no tiene aislamiento dentro de la caja del producto que puede tener una magnitud suficiente como para constituir riesgo de corrientazo.</p> <p>Dieses Symbol soll den Anwender vor unisolierten gefährlichen Spannungen innerhalb des Gehäuses warnen, die von ausreichender Stärke sind, um einen elektrischen Schlag verursachen zu können.</p>
 <b>WARNING:</b>	<p>Intended to alert the user of the presence of important operating and maintenance (Servicing) instructions in the literature accompanying the product.</p> <p>Destiné à alerter l'utilisateur de la présence d'instructions importantes d'exploitation et de maintenance (entretien) dans la documentation accompagnant le produit.</p> <p>Este símbolo tiene el propósito de la alertar al usuario de las presencias de instrucciones importantes sobre la operación y mantenimiento en la literatura que viene con el producto.</p> <p>Dieses Symbol soll den Benutzer auf wichtige Instruktionen in der Bedienungsanleitung aufmerksam machen, die Handhabung und Wartung des Produkts betreffen.</p>
<p>CAUTION: ATTENTION : PRECAUCION: VORSICHT:</p>	<p>Risk of electrical shock - DO NOT OPEN. To reduce the risk of electrical shock, do not remove the cover. No user serviceable parts inside. Refer servicing to qualified personnel.</p> <p>Risques de choc électrique - NE PAS OUVIRIR. Afin de réduire le risque de choc électrique, ne pas enlever le couvercle. Il ne se trouve a l'intérieur aucune pièce pouvant être réparée par l'utilisateur. Confier l'entretien a un personnel qualifié.</p> <p>Riesgo de descarga eléctrica - NO ABRIR. Para reducir el riesgo de descarga eléctrica, no quite la cubierta. No hay piezas reparables por el usuario en el interior. Remita el servicio a personal calificado.</p> <p>Risiko - Elektrischer Schlag! Nicht offen! Um das Risiko eines elektrischen Schlages zu vermeiden, nicht die Abdeckung entfernen. Es befinden sich keine Teile darin, die vor Anwender repariert werden konnten. Reparaturen nur von qualifiziertem Fachpersonal durchführen lassen.</p>
<p>WARNING: ADVERTISSEMENT : ADVERTENCIA: ACHTUNG:</p>	<p>To prevent electrical shock or fire hazard, do not expose this appliance to rain or moisture. Before using this appliance, please read the operating instructions for further warnings.</p> <p>Afin de prévenir les risques de décharge électrique ou de feu, n'exposez pas cet appareil a la pluie ou a l'humidité. Avant d'utiliser cet appareil, lisez les avertissements supplantais situes dans le guide.</p> <p>Para evitar descargas eléctricas o peligro de incendio, no exponga este aparato a la lluvia ni a la humedad. Antes de usar este aparato, lea las instrucciones de funcionamiento para conocer más advertencias.</p> <p>Um einen elektrischen Schlag oder Feuergefahr zu vermeiden, sollte dieses Gerät nicht dem Regen oder Feuchtigkeit ausgesetzt werden. Vor Inbetriebnahme unbedingt die Bedienungsanleitung lesen.</p>
	<p>This device complies with Part 15 of the FCC rules Operation is subject to the following two conditions:</p> <ol style="list-style-type: none"> <li>1) This device may not cause harmful interference.</li> <li>2) This device must accept any interference received, that may cause undesired operation.</li> </ol> <p>Warning: Changes or modification to the equipment not approved by Laney can void the user's authority to use the equipment.</p> <p>Note: This equipment has been tested and found to comply with the limits for Class B digital device, pursuant to Part 15 of the FCC Rules. These limits are designed to provide reasonable protection against harmful interference in a residential installation. This equipment generates, uses and can radiate radio frequency energy and if not installed and used in accordance with the instructions, may cause harmful interference to radio communications. However, there is no guarantee that interference will not occur in a particular installation. If this equipment does cause harmful interference to radio or television reception, which can be determined by turning the equipment off and on, the user is encouraged to try and correct the interference by one or more of the following measures. Reorient or relocate the receiving antenna. Increase the separation between the equipment and receiver. Connect the equipment into an outlet on a circuit different from that to which the receiver is connected. Consult the dealer or an experienced radio/TV technician for help.</p>
	<p>This product conforms to the requirements of the following European Regulations, Directives &amp; Rules: CE Mark (93/68/EEC), Low Voltage (2014/35/EU), EMC (2014/30/EU), RoHS (2011/65/EU), ErP (2009/125/EU)</p> <p>SIMPLIFIED EU DECLARATION OF CONFORMITY Full text of the EU declaration of conformity is available at the following internet address: <a href="http://support.laney.co.uk/approvals">http://support.laney.co.uk/approvals</a></p>
	<p>The object of the declaration described above is in conformity with the relevant statutory requirement Electrical Equipment (Safety) Regulations 2016, Electromagnetic Compatibility Regulations 2016, The Restriction of the use of Certain Hazardous Substances in Electrical and Electronic Equipment Regulations 2012, The Ecodesign for Energy-Related Products and Energy Information, (Amendment) (EU Exit) Regulations 2012</p>
	<p>In order to reduce environmental damage, at the end of its useful life, this product must not be disposed of along with normal household waste to landfill sites. It must be taken to an approved recycling centre according to the recommendations of the WEEE (Waste Electrical and Electronic Equipment) directive applicable in your country.</p>



LANEY AMPLIFICATION.  
STEELPARK ROAD, COOMBSWOOD BUSINESS PARK WEST, HALESOWEN, B62 8HD. UK  
FOR THE LATEST INFORMATION PLEASE VISIT [WWW.LANEY.CO.UK](http://WWW.LANEY.CO.UK)

**IN THE INTEREST OF CONTINUED DEVELOPMENT, LANEY RESERVES THE RIGHT TO AMEND PRODUCT SPECIFICATION WITHOUT PRIOR NOTIFICATION.**

V1.1

